

Features :

- Isolated mounting base 3000V~
- Solder joint technology with increased power cycling capability
- Space and weight saving

Typical Applications

- AC/DC Motor drives
- Various rectifiers
- DC supply for PWM inverter

V _{DSM} ,V _{RSM}	V _{DRM} ,V _{RRM}	品名
900V	800V	MD55T80S
1100V	1000V	MD55T100S
1300V	1200V	MD55T120S
1500V	1400V	MD55T140S
1700V	1600V	MD55T160S
1900V	1800V	MD55T180S

SYMBOL	CHARACTERISTIC	TEST CONDITIONS	T _J (°C)	VALUE			UNIT
				Min	Type	Max	
I _{T(AV)}	Mean on-state current	180° half sine wave 50Hz Single side cooled, T _C =85°C	125			55	A
I _{T(RMS)}	RMS on-state current					86	A
I _{DRM} I _{RRM}	Repetitive peak current	at V _{DRM} at V _{RRM}	125			15	mA
I _{TSM}	Surge on-state current	V _R =60%V _{RRM} ,t=10ms half sine,	125			1.7	kA
I ² t	I ² t for fusing coordination		125			14.5	10 ³ A ² s
V _{TO}	Threshold voltage		125			0.75	V
r _T	On-state slope resistance					4.05	mΩ
V _{TM}	Peak on-state voltage	I _{TM} =170A	25			1.60	V
dv/dt	Critical rate of rise of off-state voltage	V _{DM} =67%V _{DRM}	125			1000	V/μs
di/dt	Critical rate of rise of on-state current	Gate source 1.5A t _r ≤0.5μs Repetitive	125			200	A/μs
I _{GT}	Gate trigger current	V _A =12V, I _A =1A	25	30		200	mA
V _{GT}	Gate trigger voltage			0.6		2.5	V
I _H	Holding current			10		250	mA
I _L	Latching current					1000	mA
V _{GD}	Non-trigger gate voltage	V _{DM} =67%V _{DRM}	125			0.20	V
R _{th(j-c)}	Thermal resistance Junction to case	At 180° sine. Single side cooled per chip				0.470	°C/W
R _{th(c-h)}	Thermal resistance case to heatsink	At 180° sine. Single side cooled per chip				0.160	°C/W
V _{iso}	Isolation voltage	50Hz,R.M.S,t=1min,I _{iso} :1mA(MAX)		3000			V
F _m	Terminal connection torque(M5)			2.5		4.0	N·m
	Mounting torque(M6)			4.5		6.0	N·m
T _{vj}	Junction temperature			-40		125	°C
T _{stg}	Stored temperature			-40		125	°C
W _t	Weight				100		g
Outline	M16						

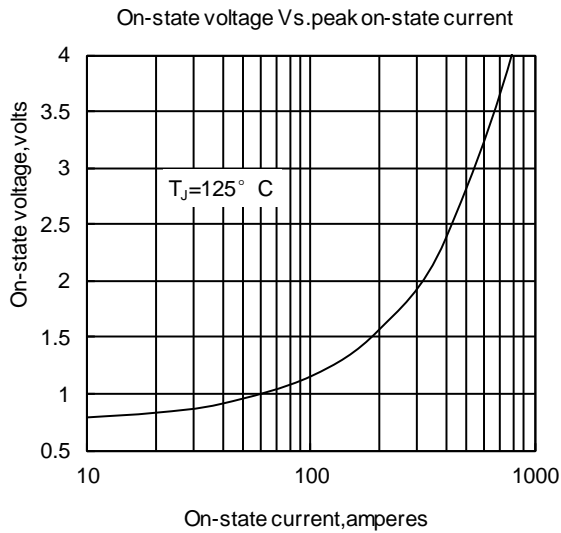

Fig1

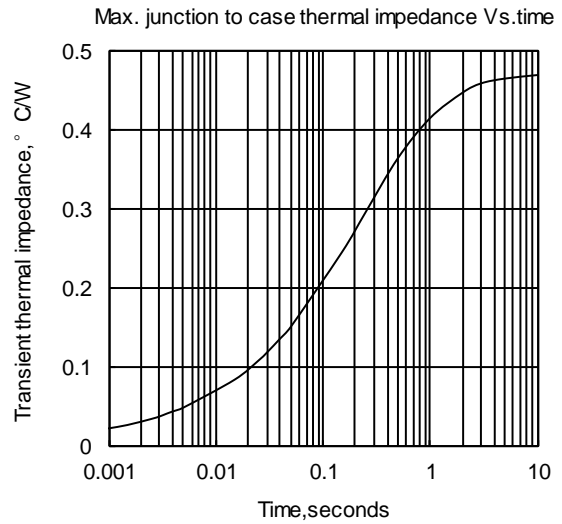

Fig2

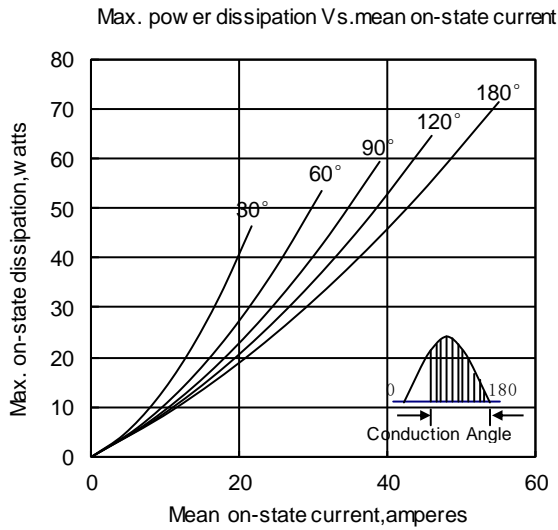

Fig3

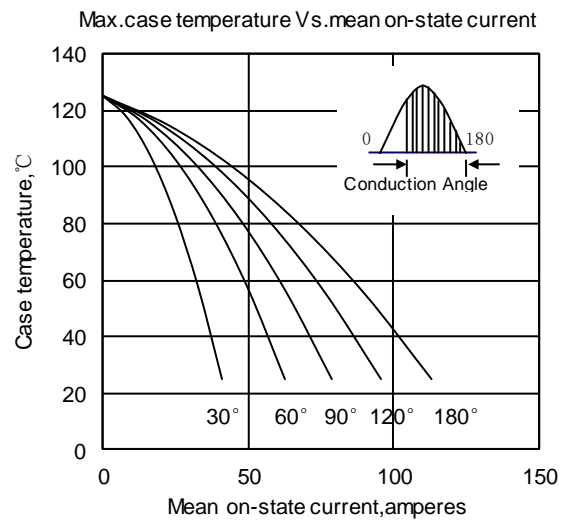

Fig4

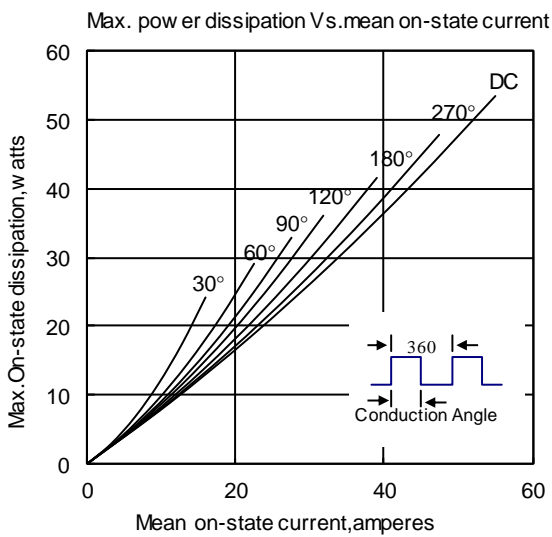

Fig5

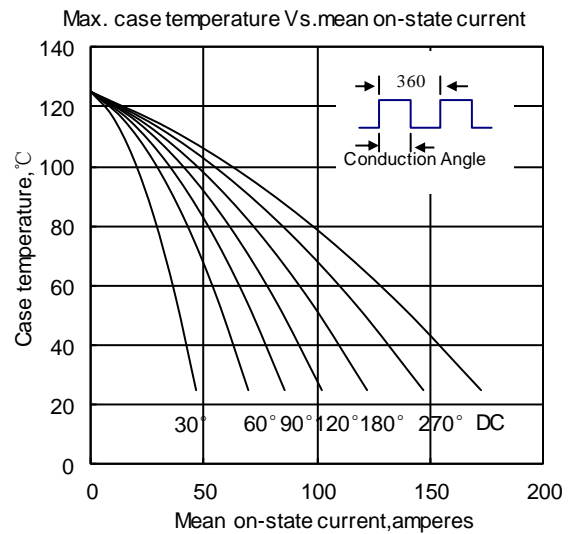

Fig6

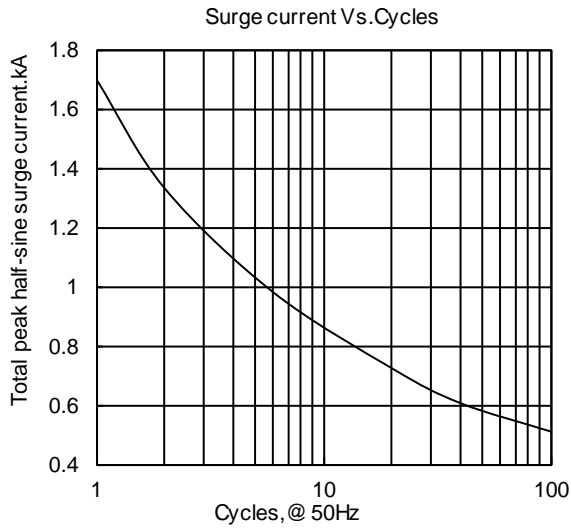

Fig7

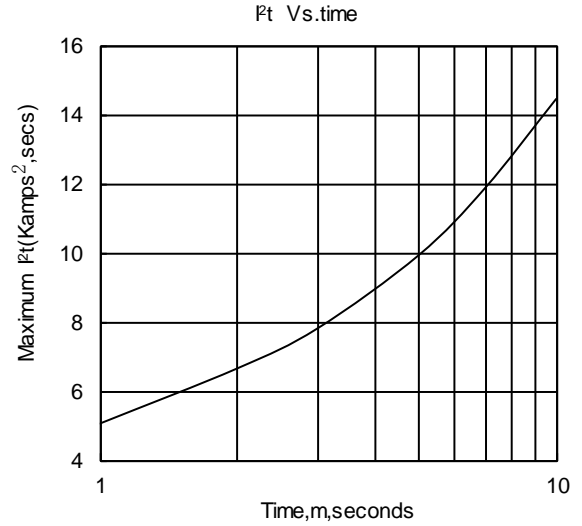

Fig8

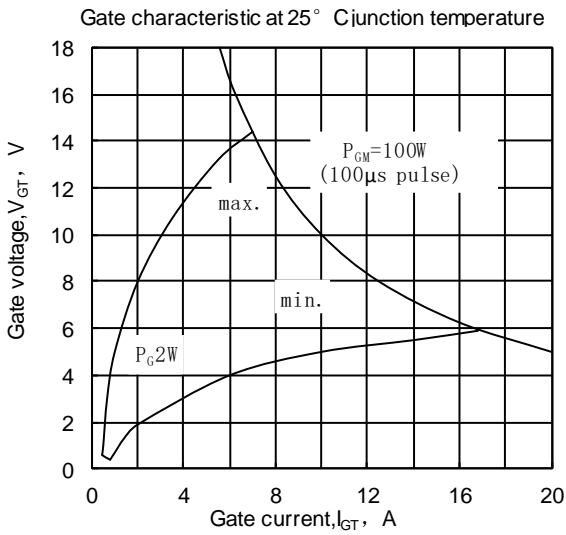

Fig9

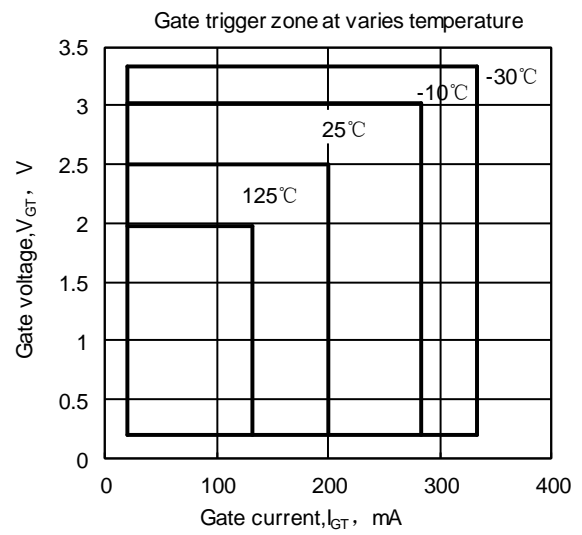
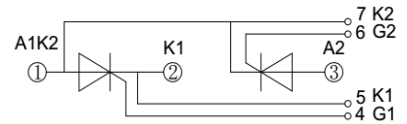
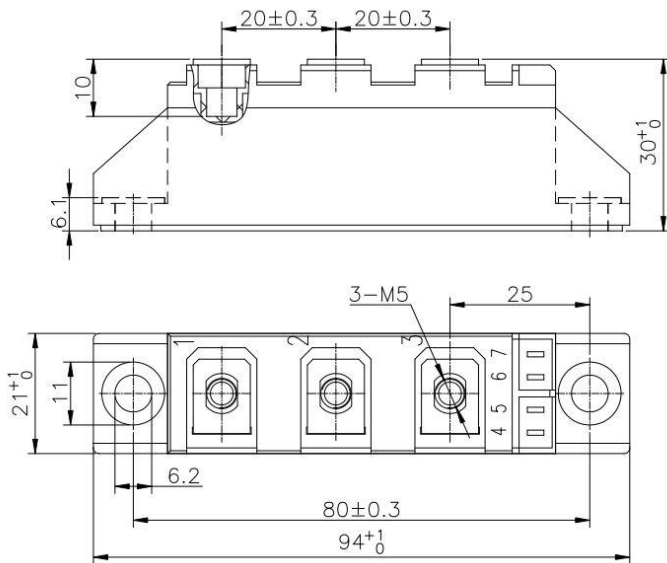

Fig10



MD55T**S

Unmarked dimensional tolerance: ±0.5mm