

**Features :**

- Isolated mounting base 3000V~
- Solder joint technology with increased power cycling capability
- Space and weight saving

**Typical Applications**

- AC/DC Motor drives
- Various rectifiers
- DC supply for PWM inverter

V <sub>DSM</sub> ,V <sub>VRSM</sub>	V <sub>DRM</sub> ,V <sub>VRRM</sub>	品名
900V	800V	MD70T80S
1100V	1000V	MD70T100S
1300V	1200V	MD70T120S
1500V	1400V	MD70T140S
1700V	1600V	MD70T160S
1900V	1800V	MD70T180S

SYMBOL	CHARACTERISTIC	TEST CONDITIONS	T <sub>J</sub> (°C)	VALUE			UNIT
				Min	Type	Max	
I <sub>T(AV)</sub>	Mean on-state current	180° half sine wave 50Hz Single side cooled, T <sub>c</sub> =85°C	125			70	A
I <sub>T(RMS)</sub>	RMS on-state current		125			110	A
I <sub>DRM</sub> I <sub>RSM</sub>	Repetitive peak current	at V <sub>DRM</sub> at V <sub>RSM</sub>	125			15	mA
I <sub>TSM</sub>	Surge on-state current	10ms half sine wave V <sub>R</sub> =60%V <sub>RSM</sub>	125			1.8	kA
I <sup>2</sup> t	I <sup>2</sup> t for fusing coordination					16.2	A <sup>2</sup> s*10 <sup>3</sup>
V <sub>TO</sub>	Threshold voltage		125			0.75	V
r <sub>T</sub>	On-state slope resistance					3.64	mΩ
V <sub>TM</sub>	Peak on-state voltage	I <sub>TM</sub> =210A	25			1.65	V
dv/dt	Critical rate of rise of off-state voltage	V <sub>DM</sub> =67%V <sub>DRM</sub>	125			1000	V/μs
di/dt	Critical rate of rise of on-state current	Gate source 1.5A t <sub>r</sub> ≤0.5μs Repetitive	125			200	A/μs
I <sub>GT</sub>	Gate trigger current	V <sub>A</sub> =12V, I <sub>A</sub> =1A	25	30		200	mA
V <sub>GT</sub>	Gate trigger voltage			0.6		2.5	V
I <sub>H</sub>	Holding current			10		250	mA
V <sub>GD</sub>	Non-trigger gate voltage	V <sub>DM</sub> =67%V <sub>DRM</sub>	125	0.2			V
R <sub>th(j-c)</sub>	Thermal resistance Junction to case	Single side cooled, per chip				0.35	°C/W
R <sub>th(c-h)</sub>	Thermal resistance case to heatsink	Single side cooled, per chip				0.15	°C/W
V <sub>iso</sub>	Isolation voltage	50Hz,R.M.S,t=1min,I <sub>iso</sub> :1mA(MAX)		3000			V
F <sub>m</sub>	Terminal connection torque(M5)			2.4		3.0	N·m
	Mounting torque(M6)			3.5		5.0	N·m
T <sub>stg</sub>	Stored temperature			-40		125	°C
W <sub>t</sub>	Weight				95		g
Outline	M16						

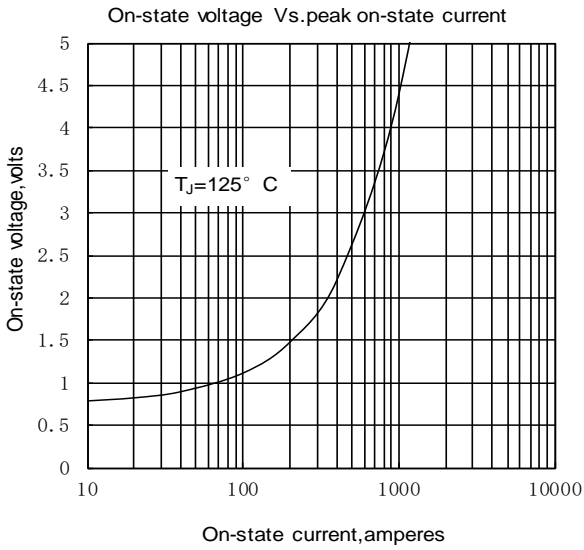

Fig1

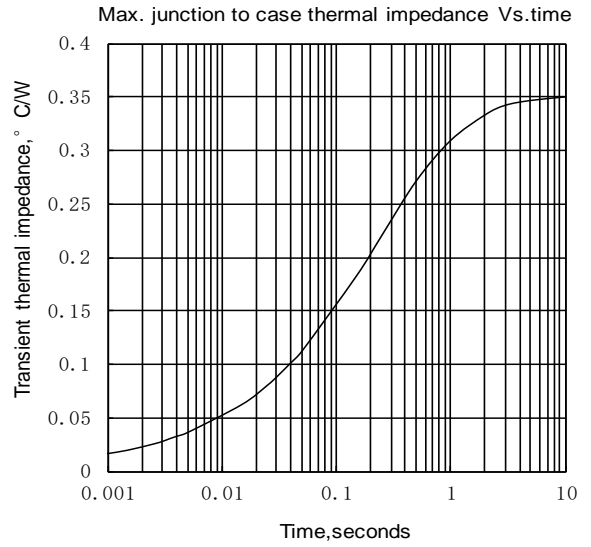

Fig2

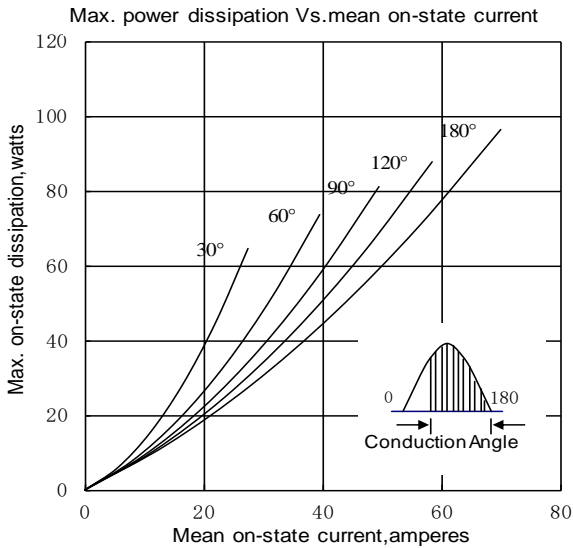

Fig3

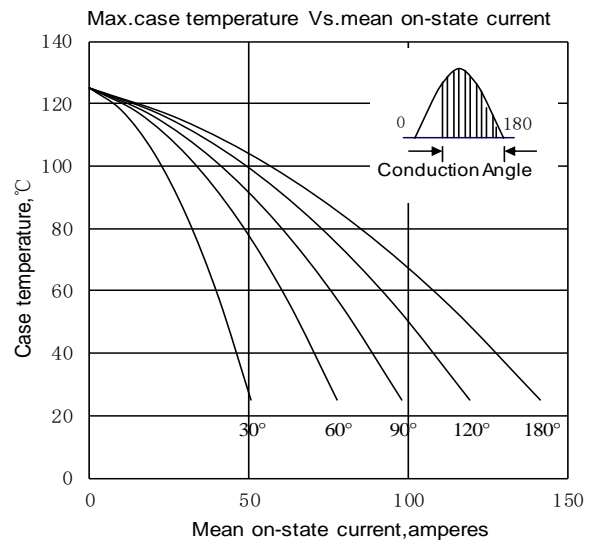

Fig4

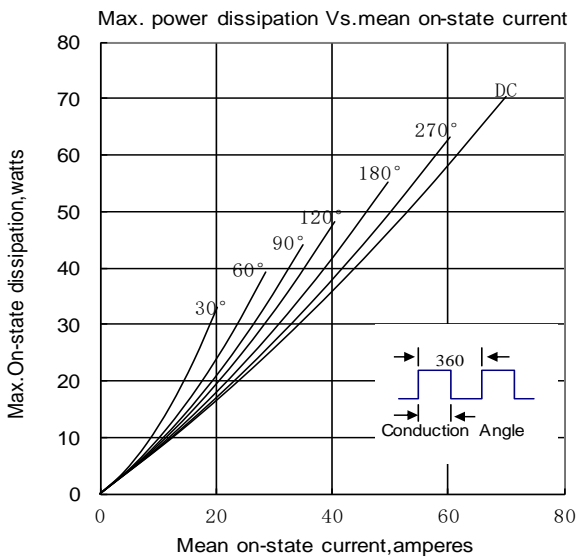

Fig5

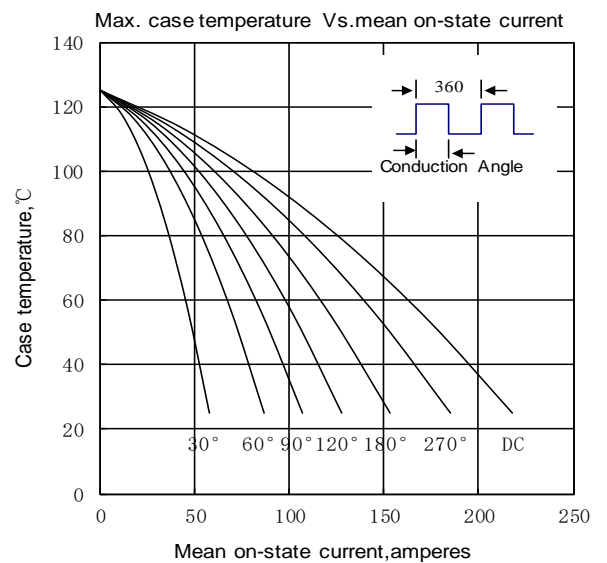

Fig6

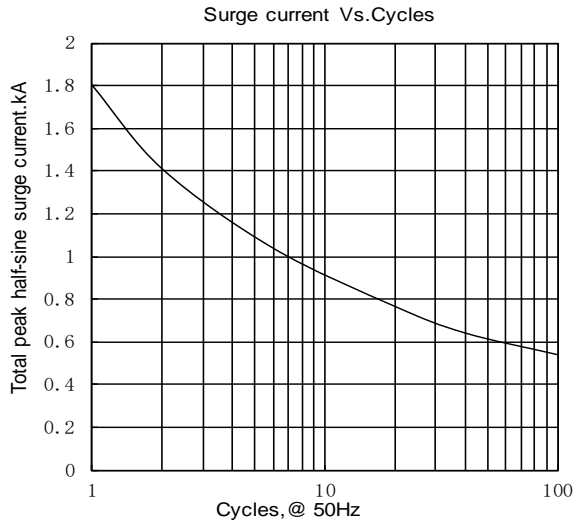

Fig7

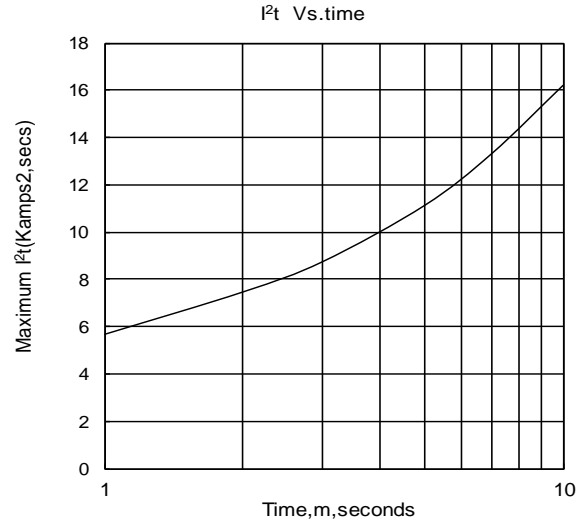

Fig8

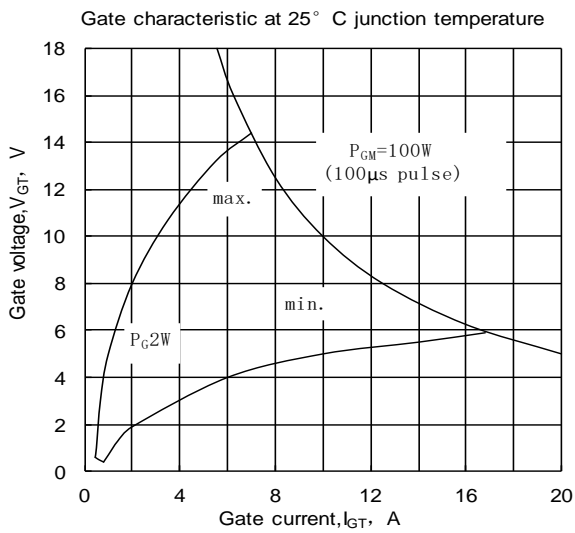

Fig9

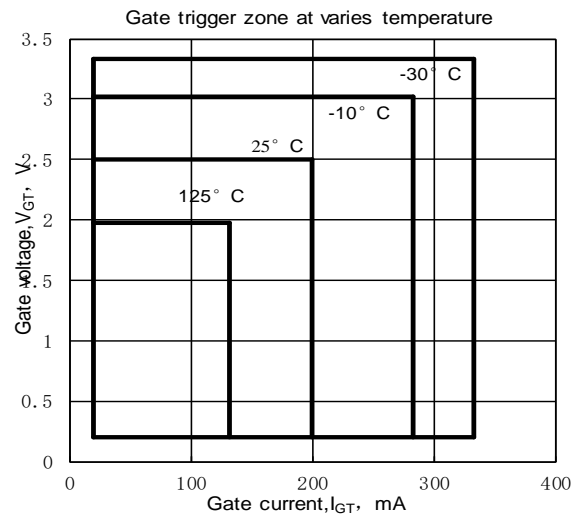
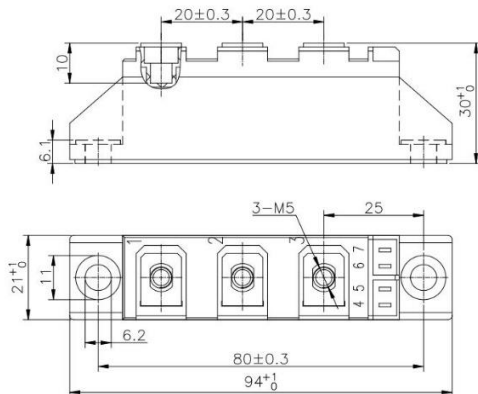
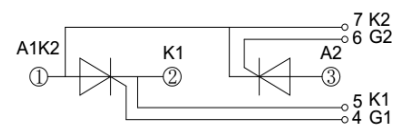

Fig10



MD70T\*\*S



Unmarked dimensional tolerance : ±0.5mm