

Features :

- Isolated mounting base 3000V~
- Pressure contact technology with
Increased power cycling capability
- Space and weight saving

Typical Applications

- Various rectifiers
- DC supply for PWM inverter

V_{RSM}	V_{RRM}	品名
2100V	2000V	Mx135D200
2300V	2200V	Mx135D220
2600V	2500V	Mx135D250

SYMBOL	CHARACTERISTIC	TEST CONDITIONS	T_j (°C)	VALUE			UNIT
				Min.	Typ.	Max.	
$I_{F(AV)}$	Mean forward current	180° half sine wave 50Hz Single side cooled, $T_c=100^\circ\text{C}$	150			135	A
$I_{F(RMS)}$	RMS forward current		150			212	A
I_{RRM}	Repetitive peak current	at V_{RRM}	150			12	mA
I_{FSM}	Surge forward current	10ms half sine wave $V_R=0.6V_{RRM}$	150			3.9	kA
I^2t	I^2t for fusing coordination					76	$\text{A}^2\text{s}\cdot 10^3$
V_{FO}	Threshold voltage		150			0.83	V
r_F	Forward slope resistance					1.23	mΩ
V_{FM}	Peak forward voltage	$I_{FM}=410\text{A}$	25			1.41	V
$R_{th(j-c)}$	Thermal resistance Junction to case	D.C. Single side cooled per chip				0.30	°C/W
$R_{th(c-h)}$	Thermal resistance case to heatsink	D.C. Single side cooled per chip				0.08	°C/W
V_{iso}	Isolation voltage	50Hz, R.M.S, $t=1\text{min}$, $I_{iso}:1\text{mA}(\text{max})$		3000			V
F_m	Terminal connection torque(M6)			3.5		5.0	N-m
	Mounting torque(M6)				6.0		N-m
T_{vj}	Junction temperature			-40		150	°C
T_{stg}	Stored temperature			-40		125	°C
W_t	Weight				320		g
Outline	M02						

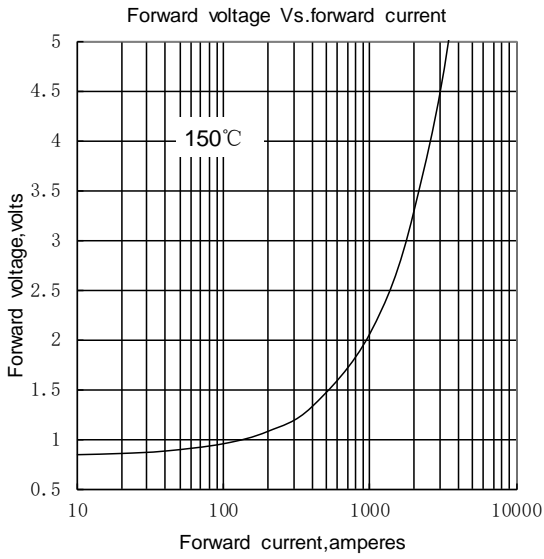

Fig.1

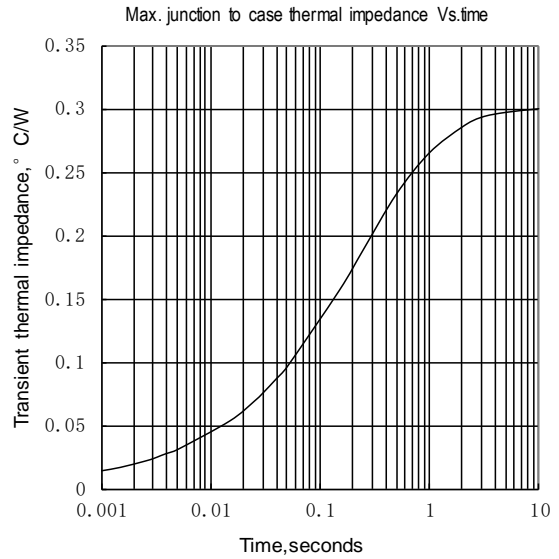

Fig.2

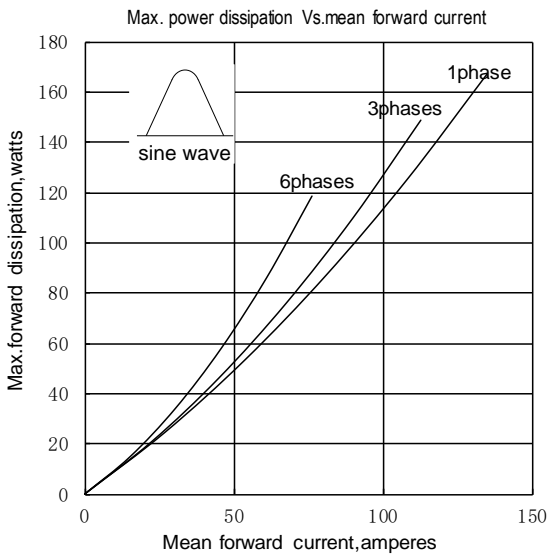

Fig.3

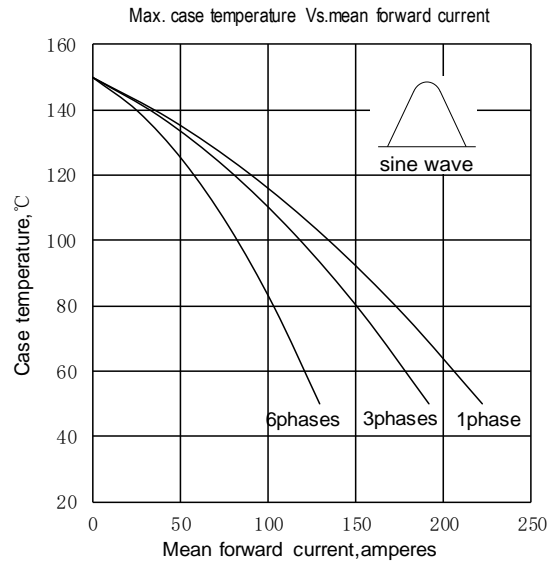

Fig.4

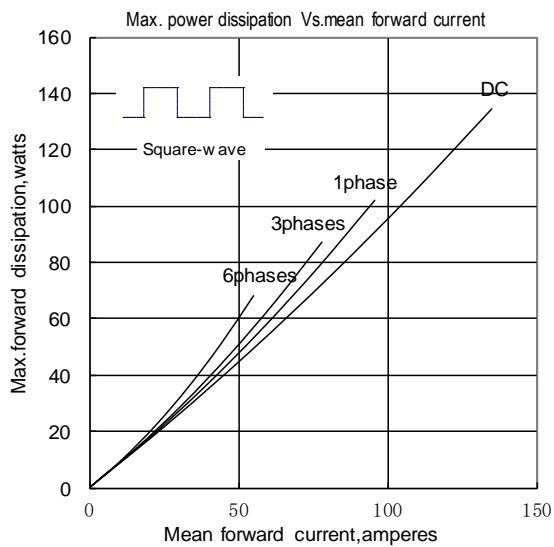

Fig.5

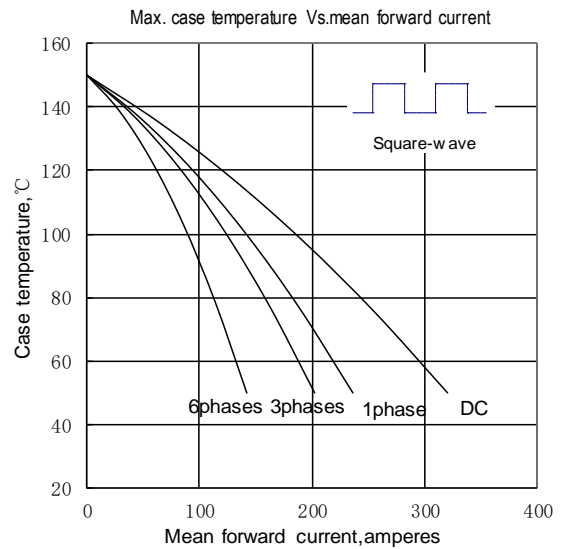

Fig.6

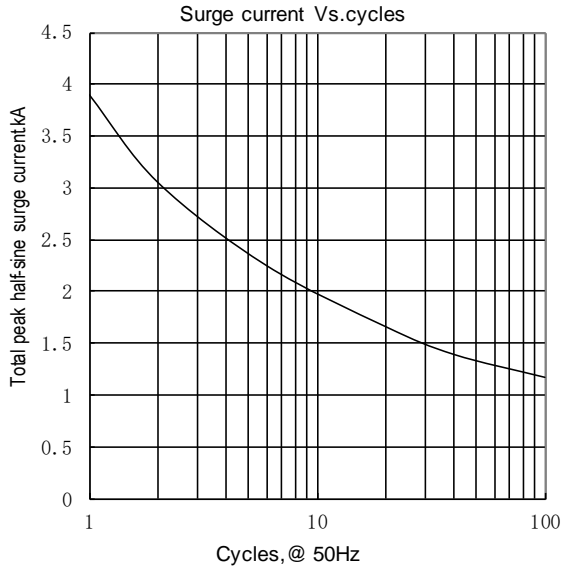
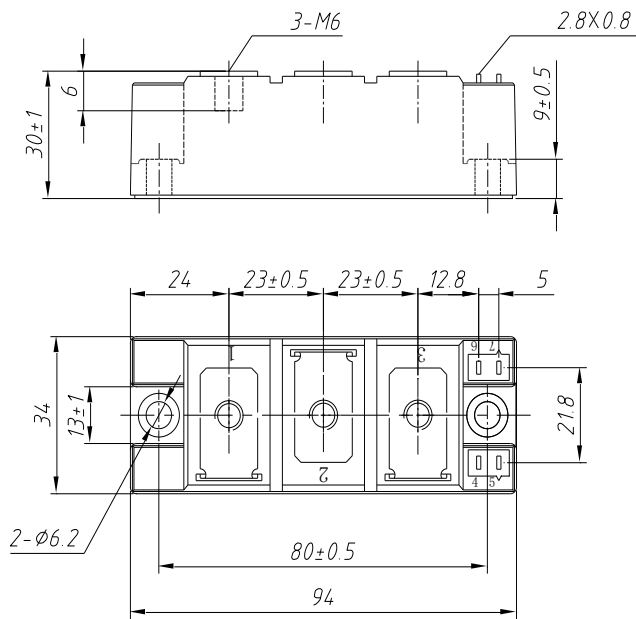
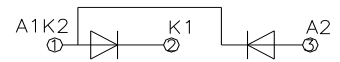

Fig.7



Unmarked dimensional tolerance : ±0.5mm

MD135D**



MR135D**

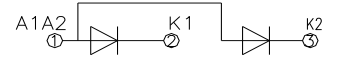

MC135D**

