

Features :

- Isolated mounting base 3000V~
- Pressure contact technology with Increased power cycling capability
- Space and weight saving

Typical Applications

- AC/DC Motor drives
- Various rectifiers
- DC supply for PWM inverter

V _{DSM} , V _{RSM}	V _{DRM} , V _{RRM}	品名
2100V	2000V	Mx135TH200
2300V	2200V	Mx135TH220
2600V	2500V	Mx135TH250

SYMBOL	CHARACTERISTIC	TEST CONDITIONS	T _j (°C)	VALUE			UNIT
				Min.	Typ.	Max.	
I _{T(AV)}	Mean on-state current	180° half sine wave 50Hz Single side cooled, T _c =85°C	125			135	A
I _{T(RMS)}	RMS on-state current					212	A
I _{DRM} I _{RRM}	Repetitive peak current	at V _{DRM} at V _{RRM}	125			30	mA
I _{TSM}	Surge on-state current	10ms half sine wave V _R =60%V _{RRM}	125			3.6	kA
I ² t	I ² t for fusing coordination					65	A ² s*10 ³
V _{TO}	Threshold voltage		125			0.85	V
r _T	On-state slope resistance					1.91	mΩ
V _{TM}	Peak on-state voltage	I _{TM} =410A	25			1.96	V
dv/dt	Critical rate of rise of off-state voltage	V _{DM} =67%V _{DRM}	125			1000	V/μs
di/dt	Critical rate of rise of on-state current	Gate source 1.5A t _r ≤0.5μs Repetitive	125			200	A/μs
I _{GT}	Gate trigger current	V _A =12V, I _A =1A	25	30		150	mA
V _{GT}	Gate trigger voltage			0.8		2.5	V
I _H	Holding current			10		150	mA
V _{GD}	Non-trigger gate voltage	V _{DM} =67%V _{DRM}	125	0.2			V
R _{th(j-c)}	Thermal resistance Junction to case	D.C. Single side cooled per chip				0.20	°C/W
R _{th(c-h)}	Thermal resistance case to heat sink	D.C. Single side cooled per chip				0.08	°C/W
V _{iso}	Isolation voltage	50Hz, R.M.S, t=1min, I _{iso} : 1mA(MAX)		3000			V
F _m	Terminal connection torque (M6)			3.5		5.0	N·m
	Mounting torque (M6)				6.0		N·m
T _{vj}	Junction temperature			-40		125	°C
T _{stg}	Stored temperature			-40		125	°C
W _t	Weight				320		g
Outline	M02						

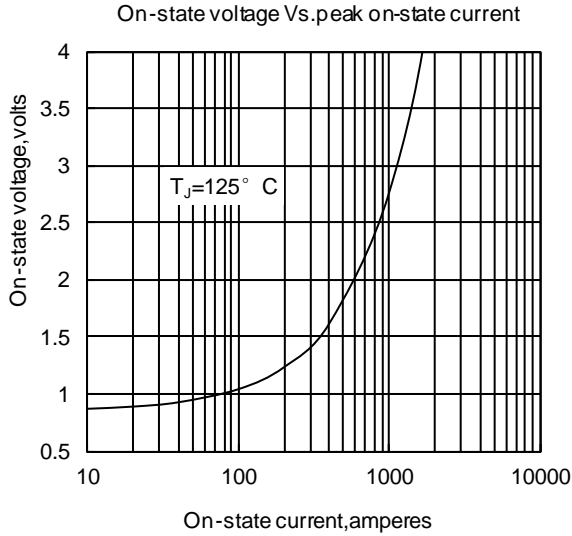

Fig. 1

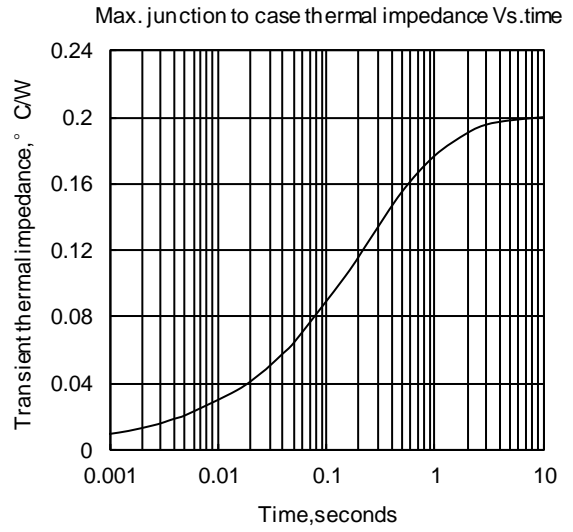

Fig. 2

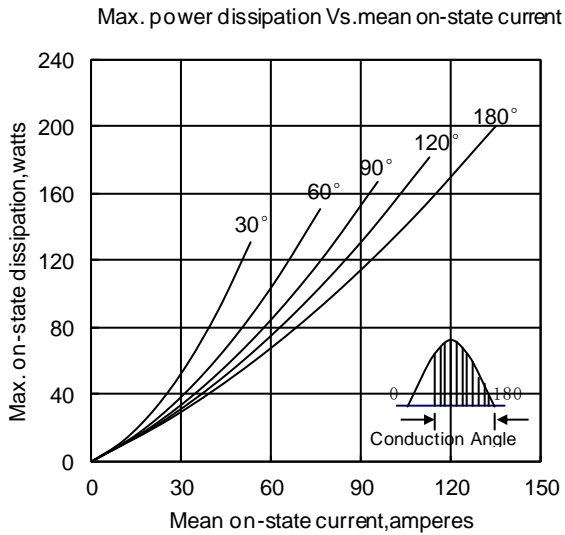

Fig. 3

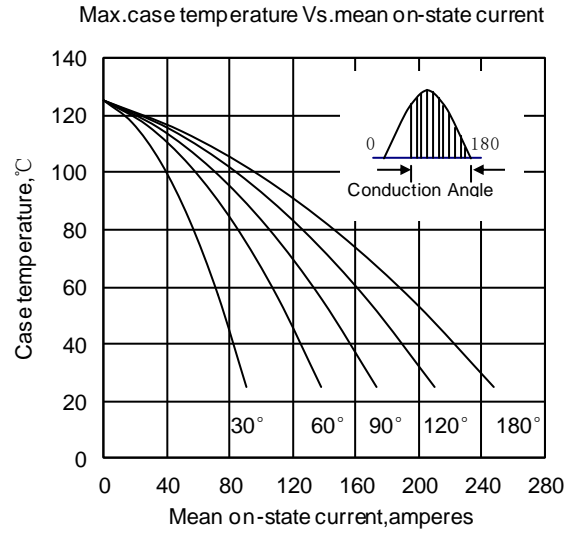

Fig. 4

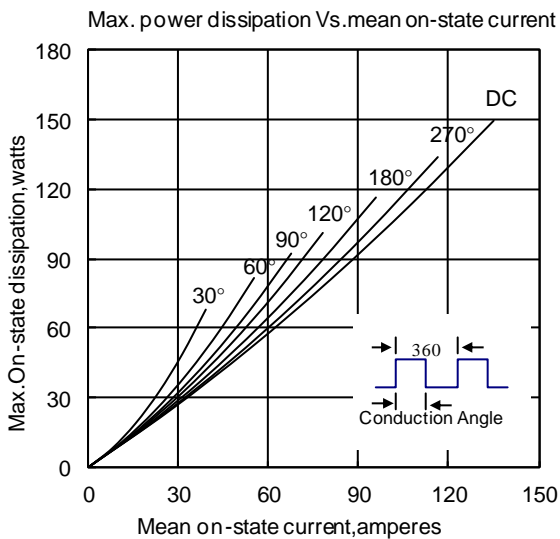

Fig. 5

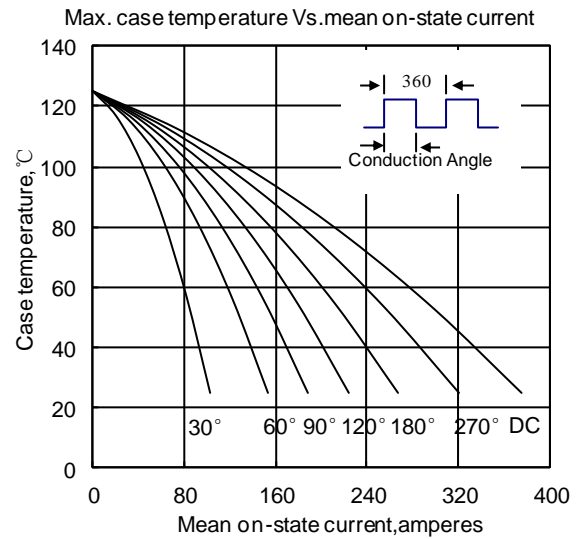

Fig. 6

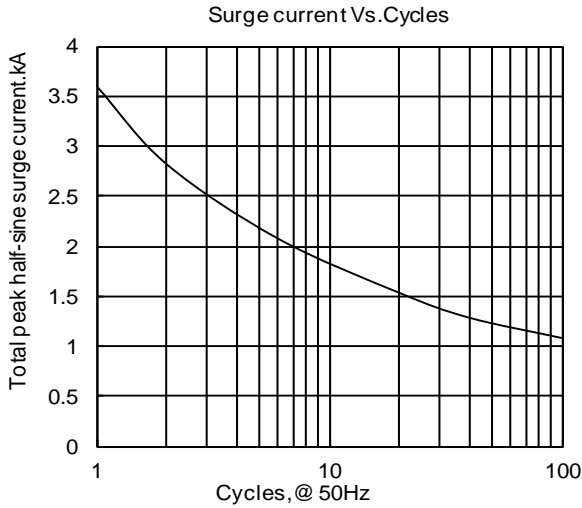

Fig. 7

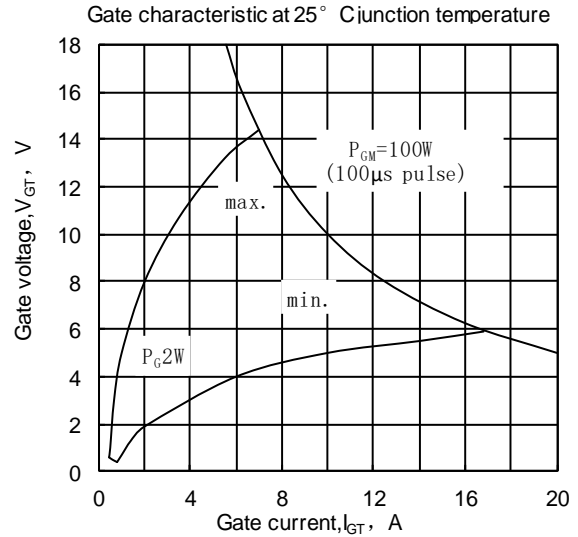

Fig8

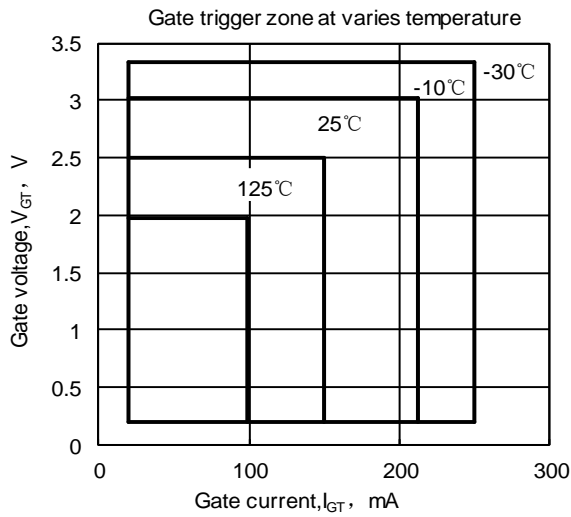
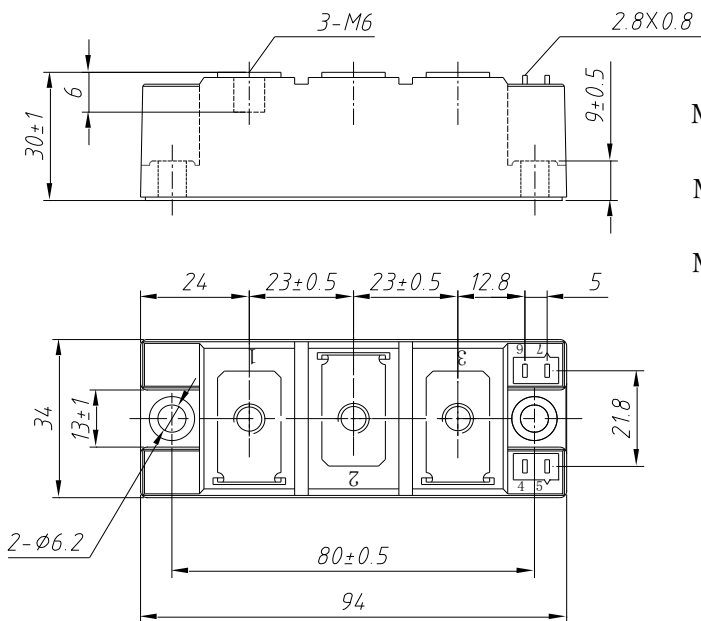
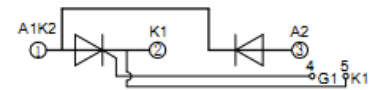

Fig9



MD135TH**



MR135TH**

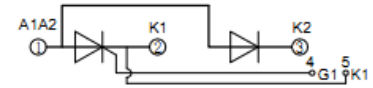

MC135TH**



Unmarked dimensional tolerance : ±0.5mm