

Features :

- Isolated mounting base 4000V~
- Pressure contact technology with Increased power cycling capability
- Space and weight saving

Typical Applications

- Various rectifiers
- DC supply for PWM inverter

V _{DSM} ,V _{RSM}	V _{DRM} ,V _{RDM}	品名
2700V	2600V	Mx400D260
3100V	3000V	Mx400D300
3700V	3600V	Mx400D360

SYMBOL	CHARACTERISTIC	TEST CONDITIONS	T _j (°C)	VALUE			UNIT
				Min.	Typ.	Max.	
I _{F(AV)}	Mean forward current	180° half sine wave 50Hz Single side cooled, T _c =100°C	150			400	A
I _{F(RMS)}	RMS forward current		150			628	A
I _{R(RM)}	Repetitive peak current	at V _{R(RM)}	150			45	mA
I _{F(SM)}	Surge forward current	10ms half sine wave V _R =0.6V _{R(RM)}	150			13	kA
I ² t	I ² t for fusing coordination					845	A ² s*10 ³
V _{FO}	Threshold voltage		150			0.95	V
r _F	Forward slope resistance					0.65	mΩ
V _{FM}	Peak forward voltage	I _{FM} =1500A	25			2.05	V
R _{th(j-c)}	Thermal resistance Junction to case	D.C. Single side cooled per chip				0.075	°C/W
R _{th(c-h)}	Thermal resistance case to heatsink	D.C. Single side cooled per chip				0.024	°C/W
V _{iso}	Isolation voltage	50Hz,R.M.S,t=1min,I _{iso} :1mA(max)		4000			V
F _m	Terminal connection torque(M10)				12.0		N·m
	Mounting torque(M6)				6.0		N·m
T _{vj}	Junction temperature			-40		150	°C
T _{stg}	Stored temperature			-40		125	°C
W _t	Weight				1500		g
Outline	M06						

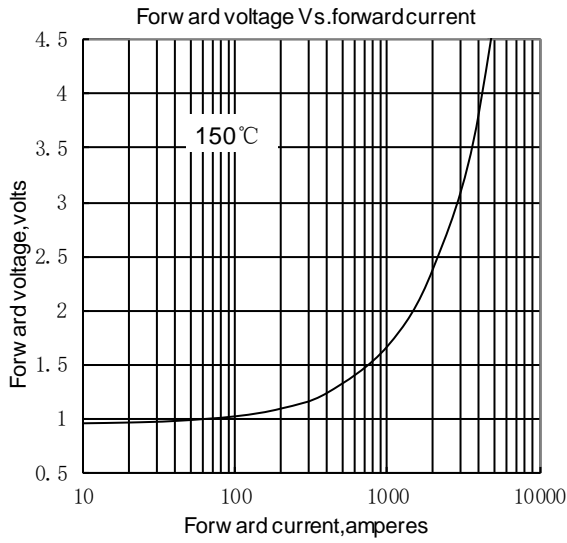

Fig.1

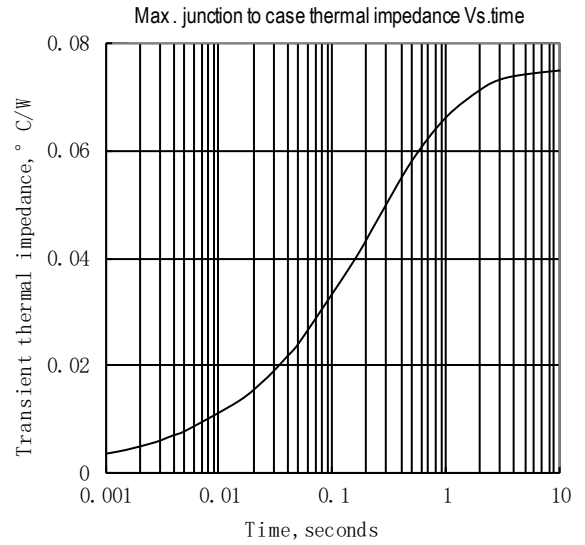

Fig.2

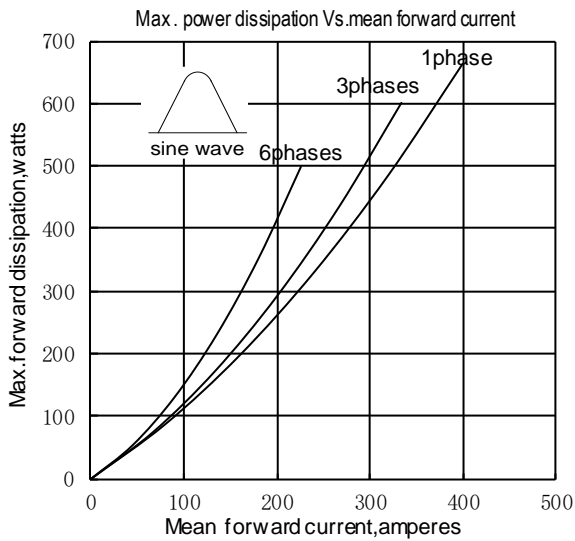

Fig.3

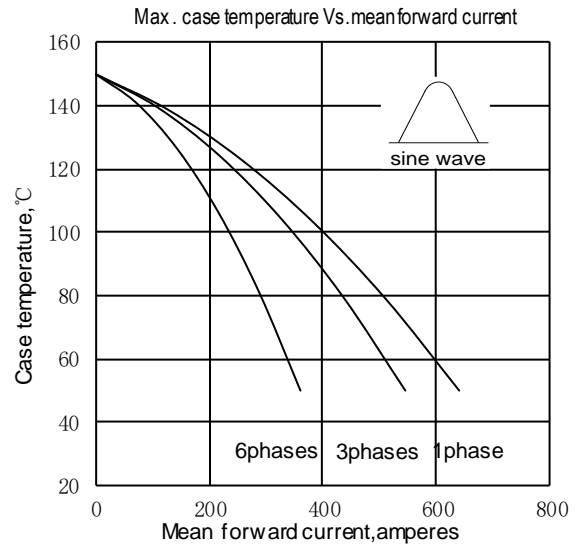

Fig.4

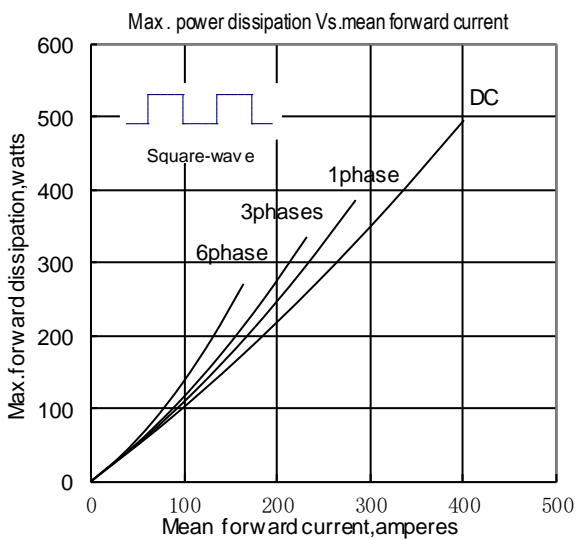

Fig.5

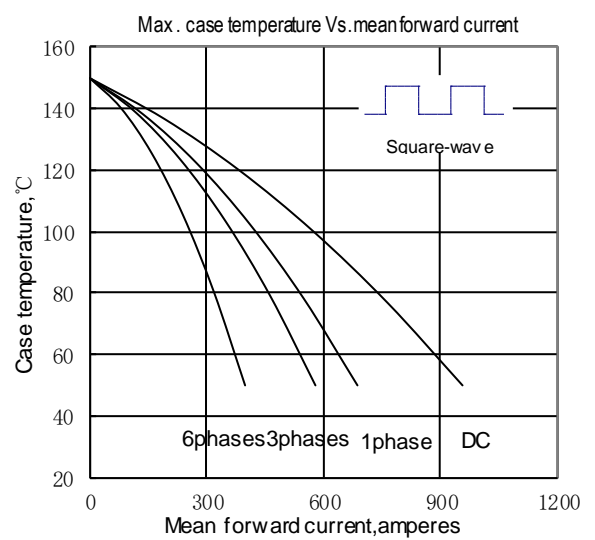

Fig.6

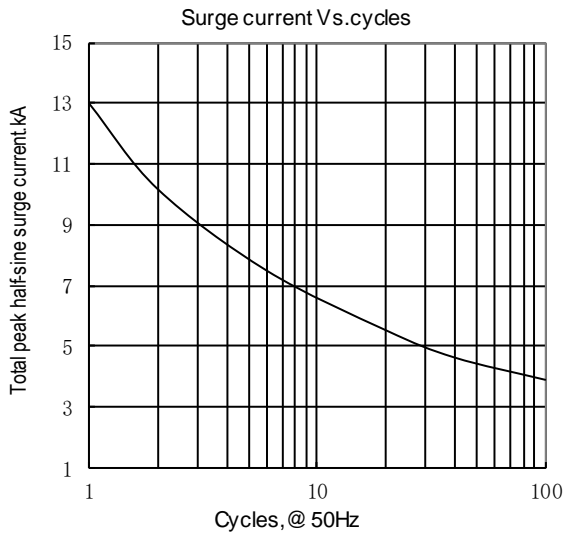
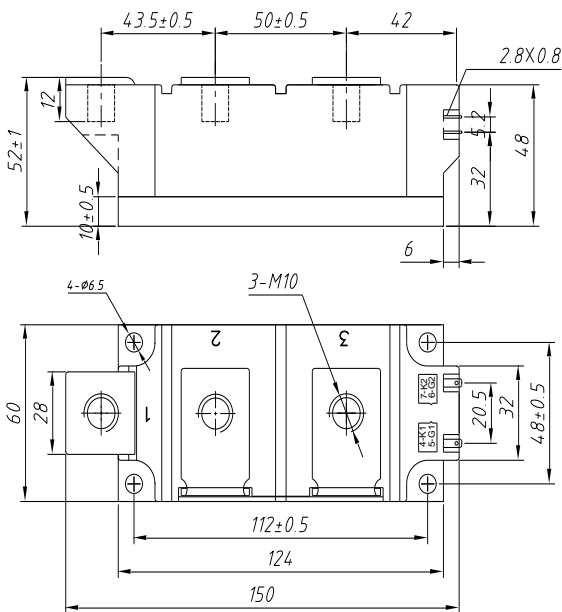
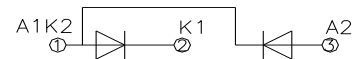

Fig.7



Unmarked dimensional tolerance : ±0.5mm

MD400D**



MR400D**

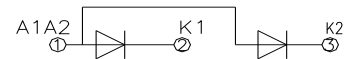

MC400D**

