

Features :

- Isolated mounting base 2500V~
- Pressure contact technology with Increased power cycling capability
- Space and weight savings

Typical Applications

- AC/DC Motor drives
- Various rectifiers
- DC supply for PWM inverter

Part No. Mx570TW**

V _{RRM} , V _{DRM}	品名
800V	Mx570T80W
1000V	Mx570T100W
1200V	Mx570T120W
1400V	Mx570T140W
1600V	Mx570T160W
1800V	Mx570T180W

SYMBOL	CHARACTERISTIC	TEST CONDITIONS	T _j (°C)	VALUE			UNIT
				Min	Type	Max	
I _{T(AV)}	Mean on-state current	180° half sine wave 50Hz Single side cooled, T _c =58°C	125			570	A
I _{T(RMS)}	RMS on-state current					895	A
V _{DRM} /V _{RRM}	Repetitive peak off-state voltage Repetitive peak reverse voltage	tp=10ms	125	800		1800	V
I _{DRM} I _{RRM}	Repetitive peak current	at V _{DRM} at V _{RRM}	125			35	mA
I _{TSM}	Surge on-state current	10ms half sine wave	125			14.0	kA
I ² t	I ² t for fusing coordination	V _R =60%V _{RRM}				980	10 ³ A ² s
V _{TO}	Threshold voltage		125			0.90	V
r _T	On-state slope resistance					0.34	mΩ
V _{TM}	Peak on-state voltage	I _{TM} =1710A	25			1.80	V
dv/dt	Critical rate of rise of off-state voltage	V _{DM} =67%V _{DRM}	125			800	V/μs
di/dt	Critical rate of rise of on-state current	Gate source 1.5A t _r ≤0.5μs Repetitive	125			100	A/μs
I _{GT}	Gate trigger current	V _A =12V, I _A =1A	25	30		200	mA
V _{GT}	Gate trigger voltage			0.8		3.0	V
I _H	Holding current			20		200	mA
V _{GD}	Non-trigger gate voltage	V _{DM} =67%V _{DRM}	125			0.2	V
I _{GD}	Non-trigger gate current	V _{DM} =67%V _{DRM}	125			10.0	mA
R _{th(j-c)}	Thermal resistance Junction to case	Single side cooled, per chip. DC				0.085	°C/W
R _{th(c-w)}	Thermal resistance case to water	Single side cooled, per chip. (6L/min)				0.051	°C/W
V _{iso}	Isolation voltage	50Hz, R.M.S, t=1min, I _{iso} : 1mA(MAX)		2500			V
F _m	Terminal connection torque(M10)			10.0		12.0	N·m
	Mounting torque(M6)			4.5		6.0	N·m
T _{vj}	Junction temperature			-40		125	°C
T _{stg}	Stored temperature			-40		125	°C
T _{water}	Water temperature	Water flow=6L/min		-		30	°C
-	Water Pressure loss					36	kPa
W _t	Weight				1750		g
Outline	M14						

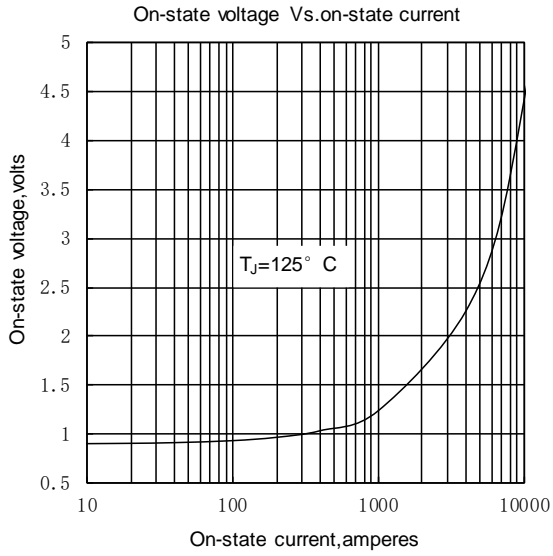

Fig.1

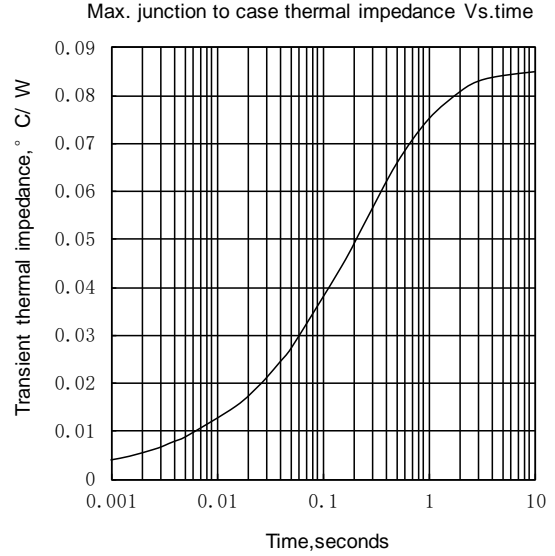

Fig.2

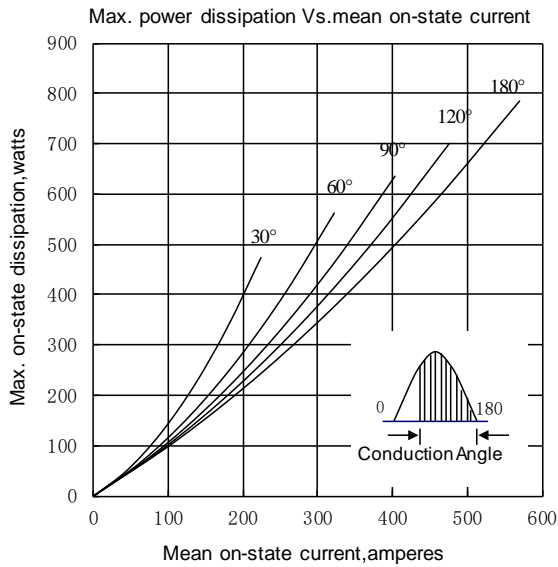

Fig.3

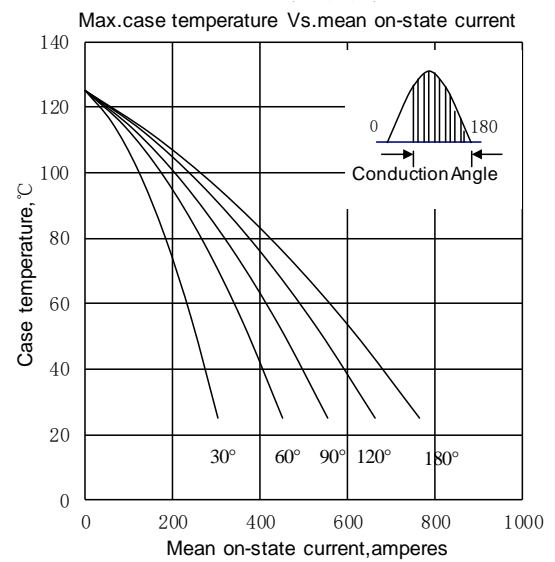

Fig.4

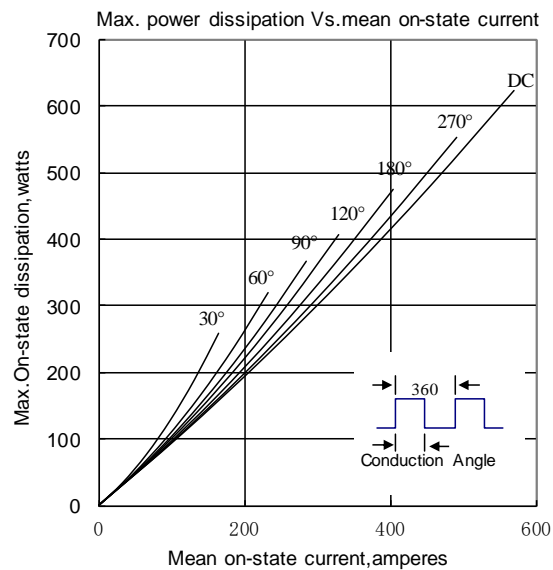

Fig.5

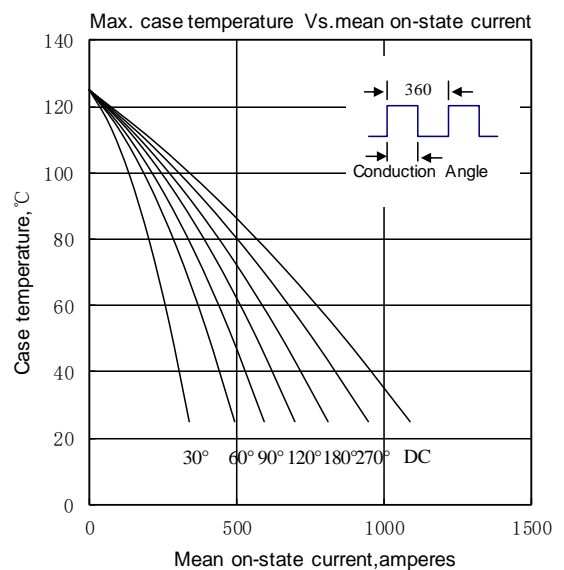

Fig.6

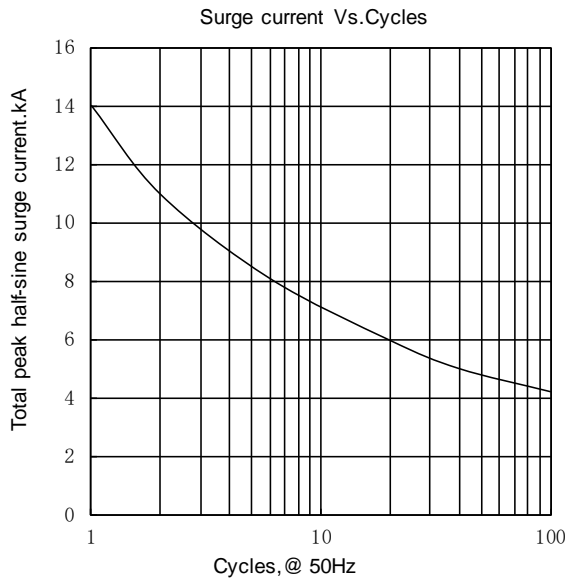

Fig.7

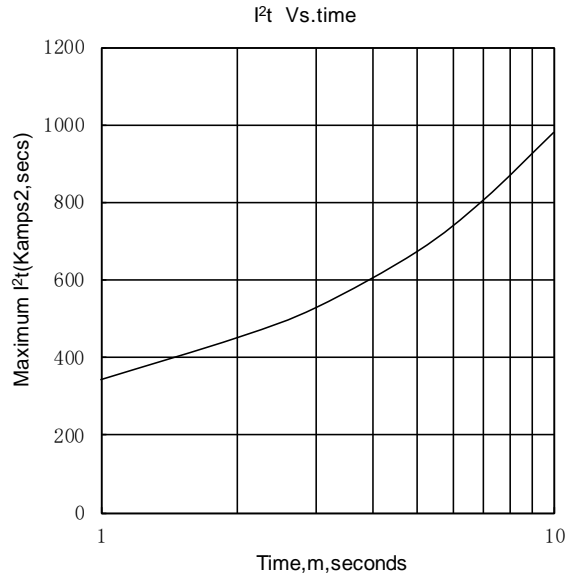

Fig.8

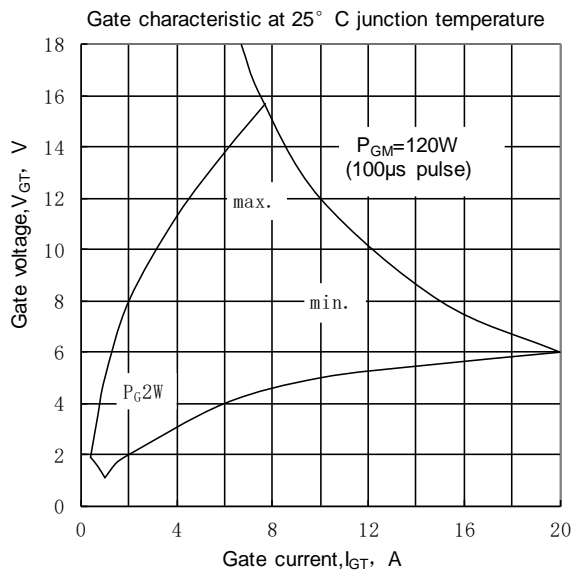

Fig.9

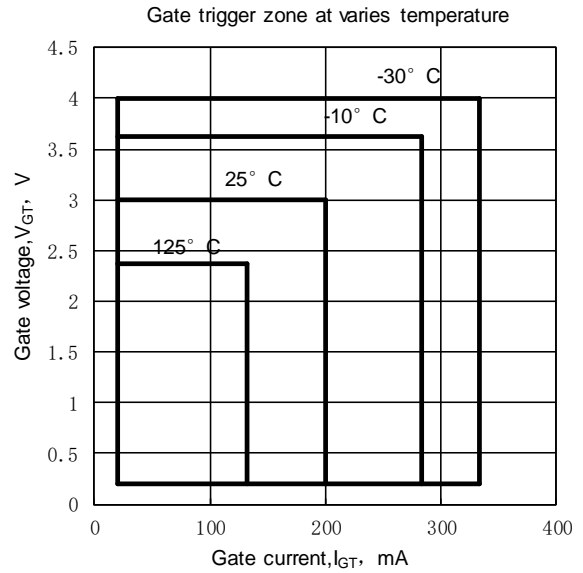

Fig.10

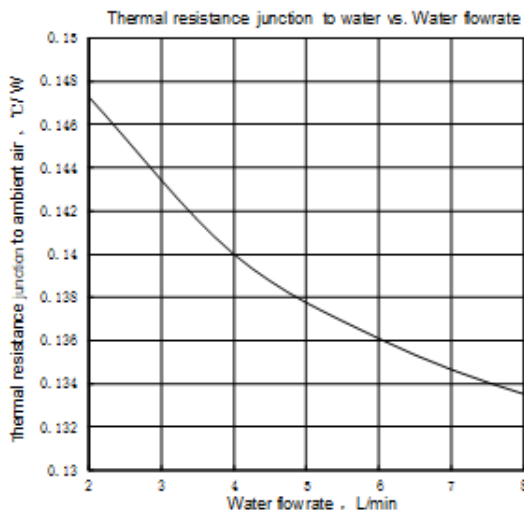

Fig.11

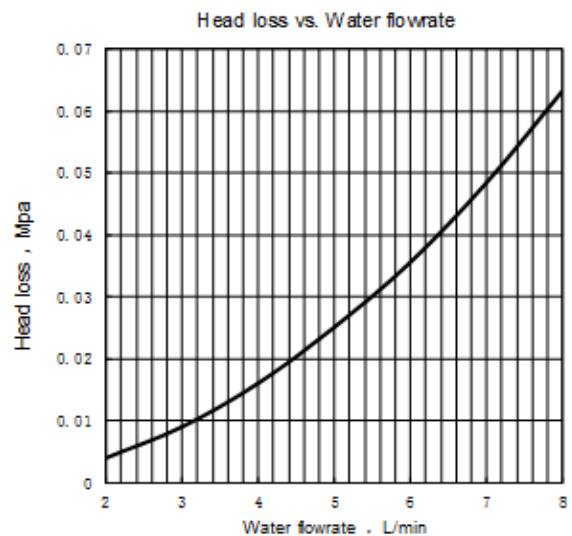
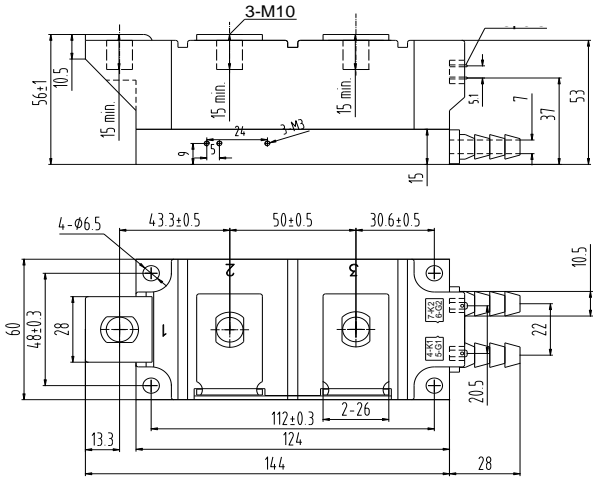
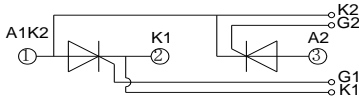

Fig.12



MD570T**W



MR570T**W

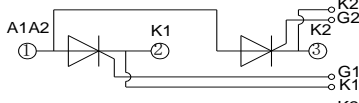

MC570T**W

