

Features:

- Isolated mounting base 4000V~
- Pressure contact technology with
Increased power cycling capability
- Space and weight saving

Typical Applications

- Various rectifiers
- DC supply for PWM inverter

V _{DSM} , V _{RSM}	V _{DRM} , V _{RRM}	品名
2700V	2600V	Mx600D260
3100V	3000V	Mx600D300
3700V	3600V	Mx600D360

SYMBOL	CHARACTERISTIC	TEST CONDITIONS	T _j (°C)	VALUE			UNIT
				Min.	Typ.	Max.	
I _{F(AV)}	Mean forward current	180° half sine wave 50Hz Single side cooled, T _C =100°C	150			600	A
I _{F(RMS)}	RMS forward current		150			942	A
I _{RRM}	Repetitive peak current	at V _{RRM}	150			50	mA
I _{FSM}	Surge forward current	10ms half sine wave V _R =0.6V _{RRM}	150			17.0	kA
I ² t	I ² t for fusing coordination					1445	A ² s*10 ³
V _{FO}	Threshold voltage		150			0.95	V
r _F	Forward slope resistance					0.22	mΩ
V _{FM}	Peak forward voltage	I _{FM} =1800A	25			1.86	V
R _{th(j-c)}	Thermal resistance Junction to case	D.C. Single side cooled per chip				0.065	°C/W
R _{th(c-h)}	Thermal resistance case to heatsink	D.C. Single side cooled per chip				0.024	°C/W
V _{ISO}	Isolation voltage	50Hz, R.M.S, t=1min, I _{ISO} : 1mA(max)		4000			V
F _m	Terminal connection torque(M12)				14.0		N·m
	Mounting torque(M8)				12.0		N·m
T _{vj}	Junction temperature			-40		150	°C
T _{stg}	Stored temperature			-40		125	°C
W _t	Weight				3240		g
Outline	M07						

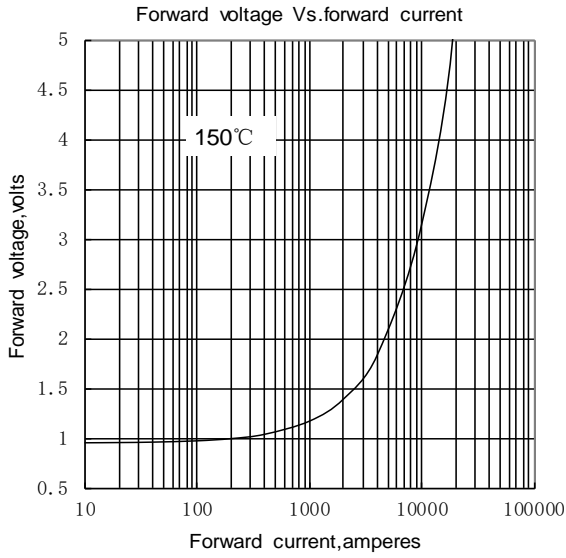

Fig.1

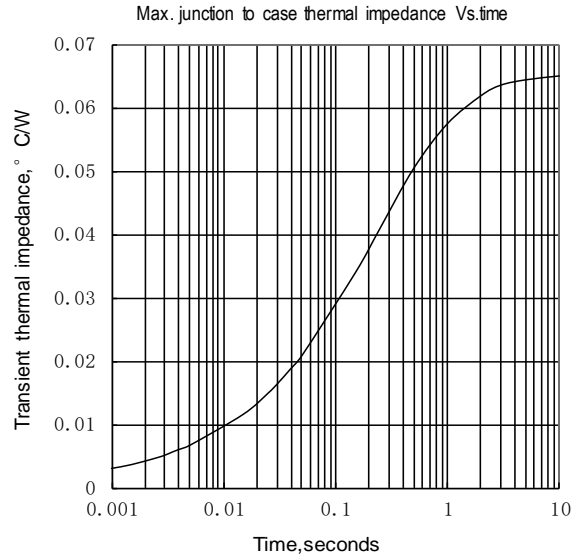

Fig.2

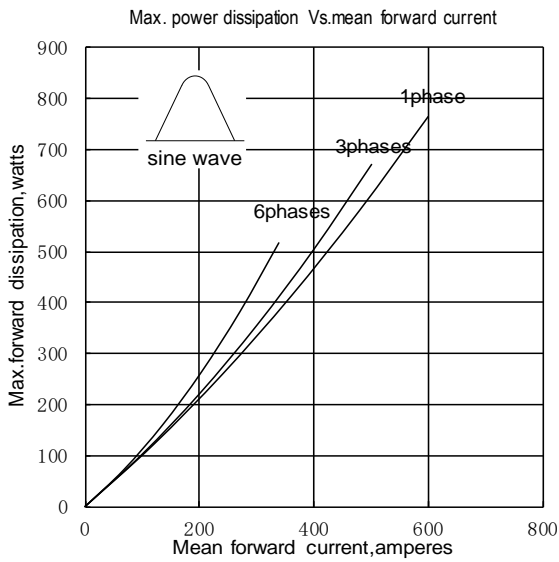

Fig.3

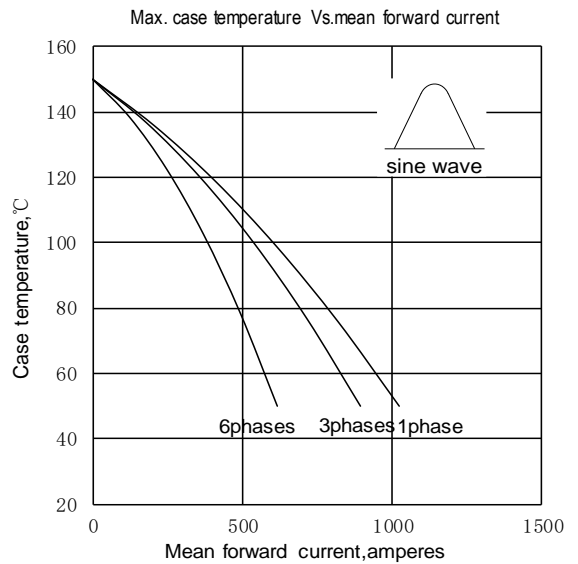

Fig.4

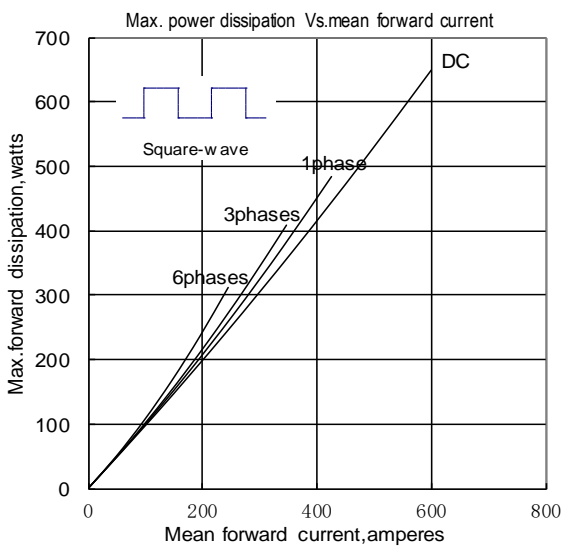

Fig.5

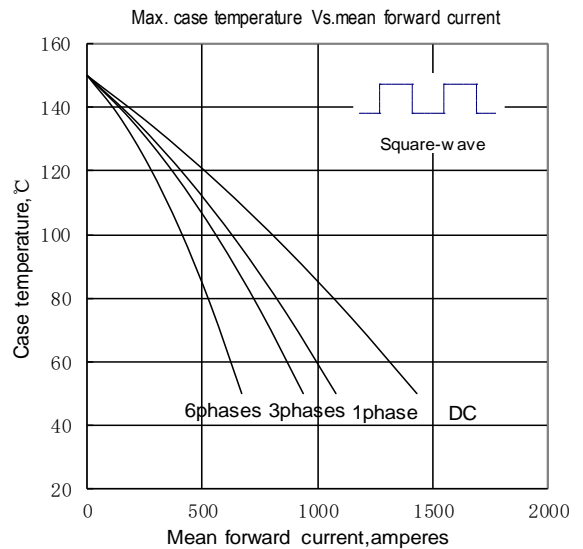

Fig.6

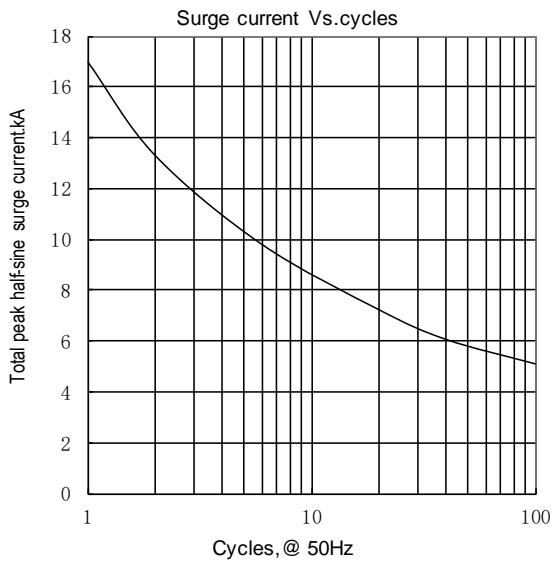
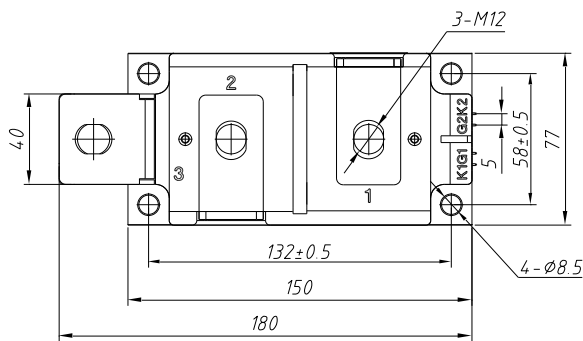
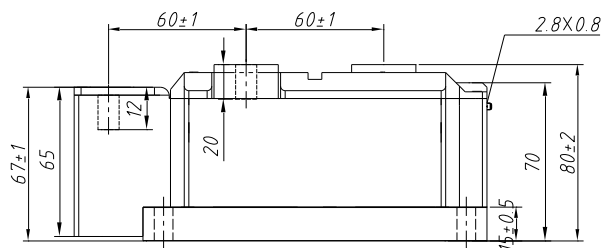
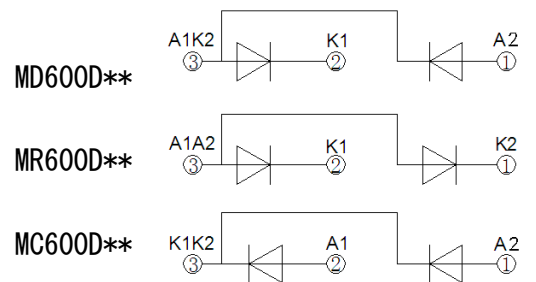

Fig.7



Unmarked dimensional tolerance : ±0.5mm



Nlps reserves the right to change specifications without notice.