

**Features:**

- Isolated mounting base3000V~
- Pressure contact technology with  
Increased power cycling capability
- Space and weight saving

**Typical Applications**

- Various rectifiers
- DC supply for PWM inverter

$V_{RSM}$	$V_{RRM}$	品名
2100V	2000V	Mx70D200
2300V	2200V	Mx70D220
2600V	2500V	Mx70D250

SYMBOL	CHARACTERISTIC	TEST CONDITIONS	$T_j(^{\circ}C)$	VALUE			UNIT
				Min.	Typ.	Max.	
$I_{F(AV)}$	Mean forward current	180° half sine wave 50Hz Single side cooled, $T_c=100^{\circ}C$	150			70	A
$I_{F(RMS)}$	RMS forward current		150			110	A
$I_{RRM}$	Repetitive peak current	at $V_{RRM}$	150			8	mA
$I_{FSM}$	Surge forward current	10ms half sine wave $V_R=0.6V_{RRM}$	150			1.80	kA
$I^2t$	$I^2t$ for fusing coordination					16.2	$A^2s \cdot 10^3$
$V_{FO}$	Threshold voltage		150			0.85	V
$r_F$	Forward slope resistance					2.73	m $\Omega$
$V_{FM}$	Peak forward voltage	$I_{FM}=210A$	25			1.50	V
$R_{th(j-c)}$	Thermal resistance Junction to case	D.C. · Single side cooled per chip				0.55	$^{\circ}C/W$
$R_{th(c-h)}$	Thermal resistance case to heatsink	D.C. · Single side cooled per chip				0.20	$^{\circ}C/W$
$V_{iso}$	Isolation voltage	50Hz, R.M.S., $t=1min, I_{iso}: 1mA(max)$		3000			V
$F_m$	Terminal connection torque(M5)			2.4		3.0	N·m
	Mounting torque(M6)				6.0		N·m
$T_{vj}$	Junction temperature			-40		150	$^{\circ}C$
$T_{stg}$	Stored temperature			-40		125	$^{\circ}C$
$W_t$	Weight				170		g
Outline	M01						

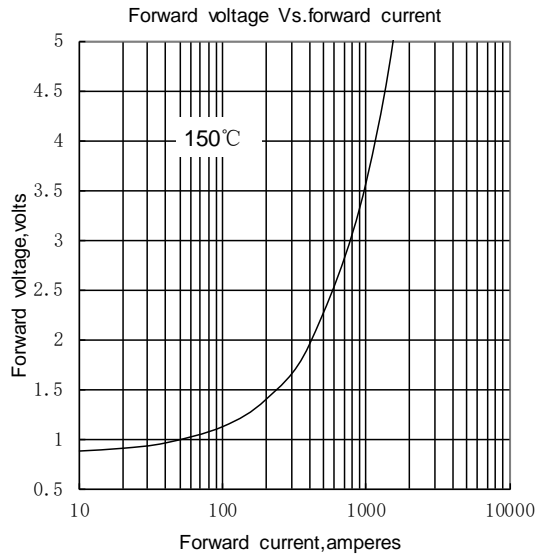

Fig.1

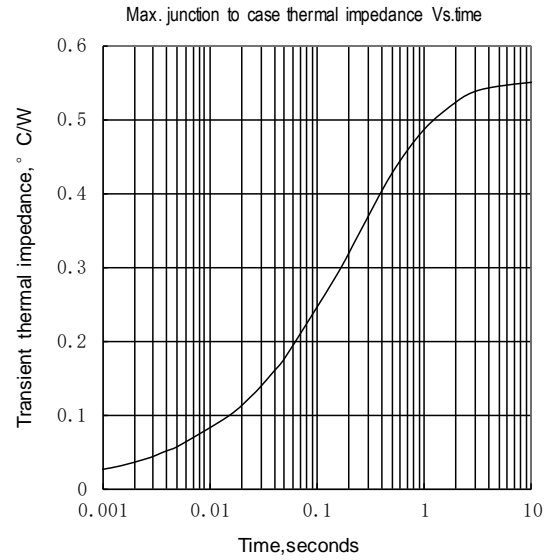

Fig.2

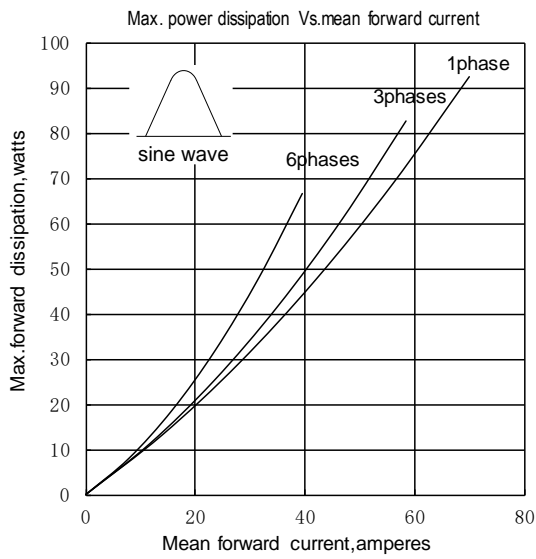

Fig.3

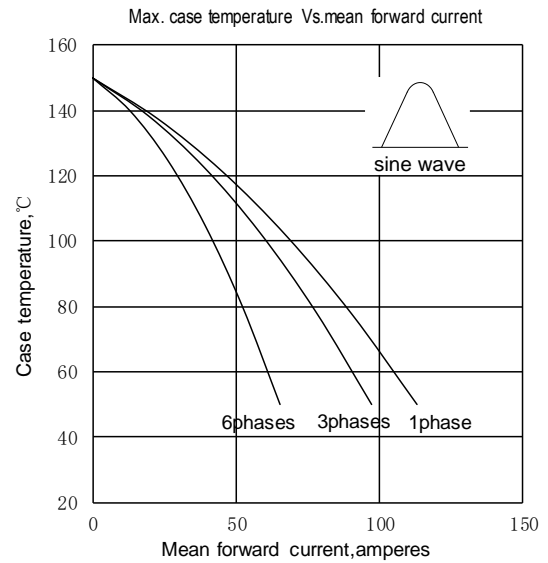

Fig.4

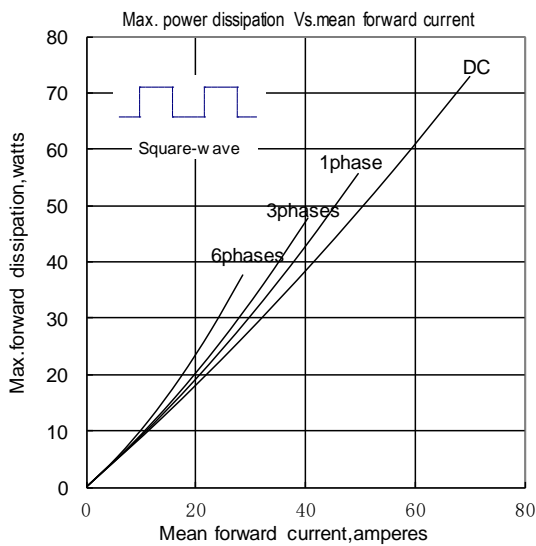

Fig.5

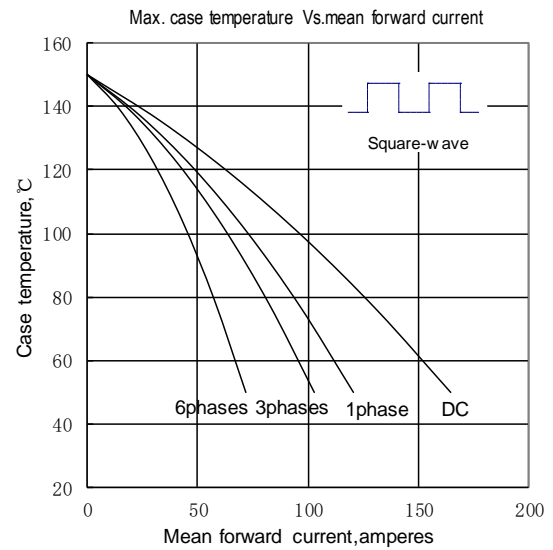

Fig.6

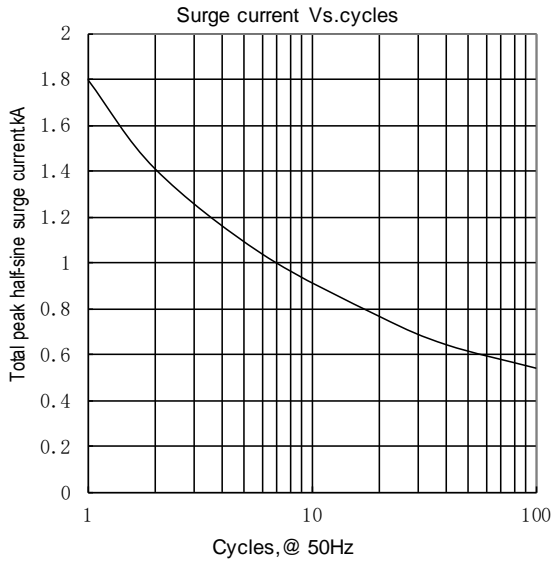
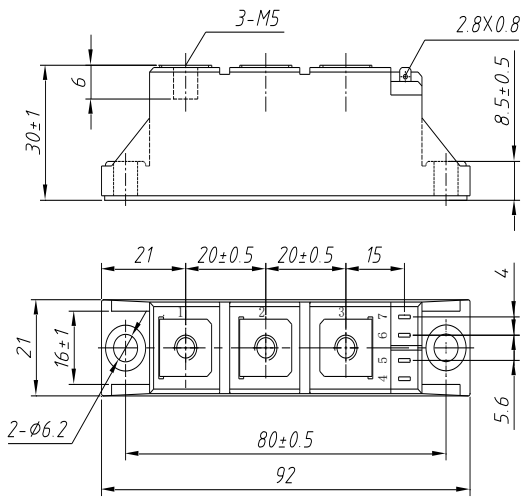
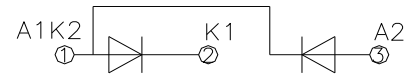

Fig.7



Unmarked dimensional tolerance : ±0.5mm

MD70D\*\*



MR70D\*\*

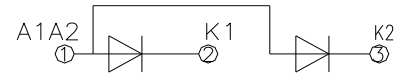

MC70D\*\*

