

Features :

- Isolated mounting base 2500V~
- Pressure contact technology with Increased power cycling capability
- Space and weight saving

Typical Applications

- AC/DC Motor drives
- Various rectifiers
- DC supply for PWM inverter

V _{DSM} ,V _{RSM}	V _{DRM} ,V _{RRM}	品名
900V	800V	Mx800T80W
1100V	1000V	Mx800T100W
1300V	1200V	Mx800T120W
1500V	1400V	Mx800T140W
1700V	1600V	Mx800T160W
1900V	1800V	Mx800T180W

SYMBOL	CHARACTERISTIC	TEST CONDITIONS	T _J (°C)	VALUE			UNIT
				Min	Type	Max	
I _{T(AV)}	Mean on-state current	180° half sine wave 50Hz Single side cooled, T _c =55°C	125			800	A
I _{T(RMS)}	RMS on-state current					1256	A
V _{DRM} /V _{RRM}	Repetitive peak off-state voltage Repetitive peak reverse voltage	tp=10ms	125	800		1800	V
I _{DRM} /I _{RRM}	Repetitive peak current	at V _{DRM} at V _{RRM}	125			45	mA
I _{TSM}	Surge on-state current	10ms half sine wave V _R =60%V _{RRM}	125			22.0	kA
I ² t	I ² t for fusing coordination					2420	A ² s*10 ³
V _{TO}	Threshold voltage		125			0.80	V
r _T	On-state slope resistance					0.42	mΩ
V _{TM}	Peak on-state voltage	I _{TM} =2400A	25			1.95	V
dv/dt	Critical rate of rise of off-state voltage	V _{DM} =67%V _{DRM}	125			800	V/μs
di/dt	Critical rate of rise of on-state current	Gate source 1.5A t _r ≤0.5μs Repetitive	125			100	A/μs
I _{GT}	Gate trigger current	V _A =12V, I _A =1A	25	30		200	mA
V _{GT}	Gate trigger voltage			1.0		3.0	V
I _H	Holding current			20		200	mA
V _{GD}	Non-trigger gate voltage	V _{DM} =67%V _{DRM}	125	0.2			V
I _{GD}	Non-trigger gate current	V _{DM} =67%V _{DRM}	125	1.5			mA
R _{th(j-c)}	Thermal resistance Junction to case	Single side cooled, per chip. DC				0.054	°C/W
R _{th(c-w)}	Thermal resistance case to water	Single side cooled, per chip. (6L/min)				0.042	°C/W
V _{iso}	Isolation voltage	50Hz, R.M.S, t=1min, I _{iso} :1mA(MAX)		2500			V
F _m	Terminal connection torque(M12)			12.0		16.0	N·m
	Mounting torque(M8)			8.0		12.0	N·m
T _{vj}	Junction temperature			-40		125	°C
T _{stg}	Stored temperature			-40		125	°C
T _{water}	Water temperature	Water flow=6L/min		-		30	°C
-	Water Pressure loss					41	kPa
W _t	Weight					3220	g
Outline	M15						

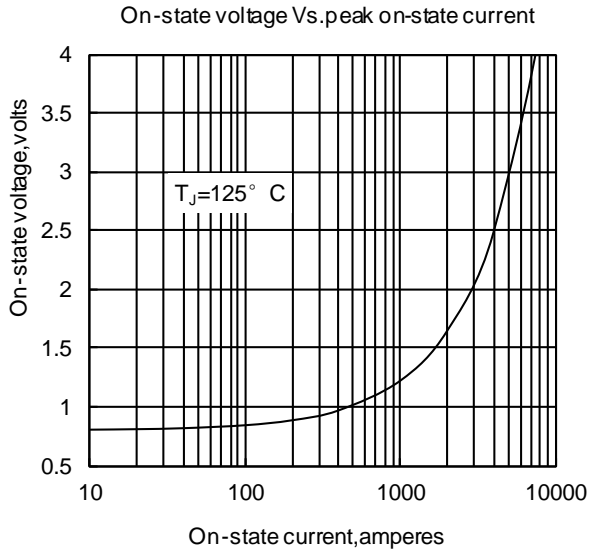

Fig1

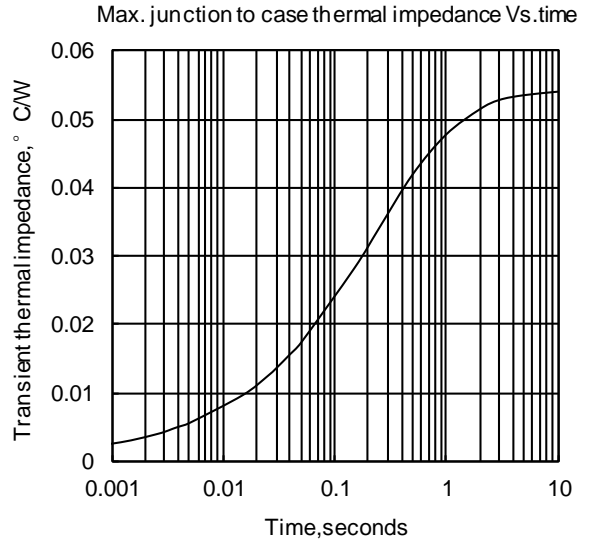

Fig2

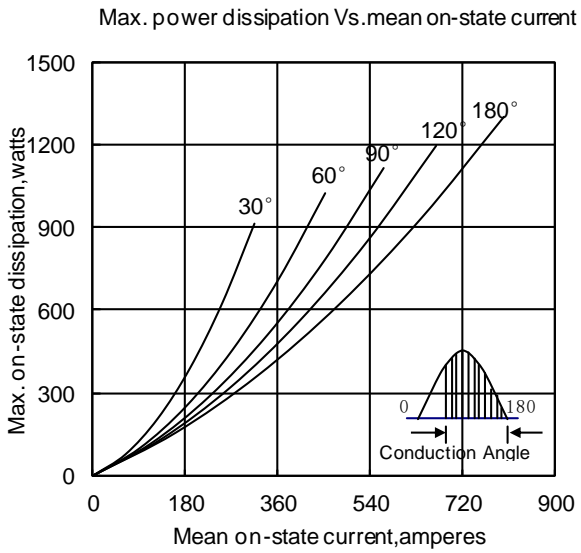

Fig3

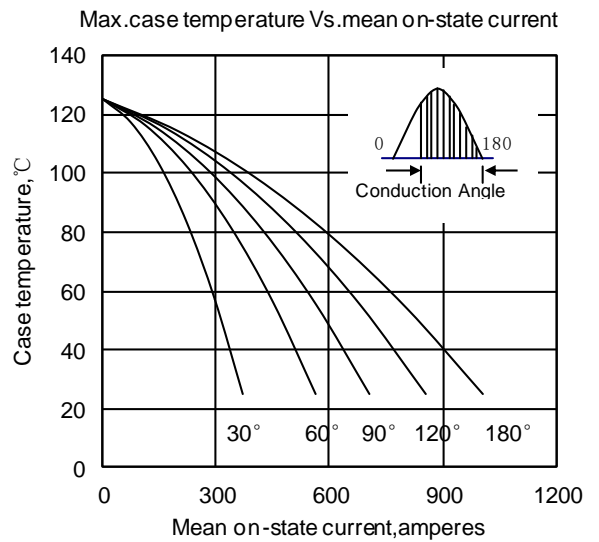

Fig4

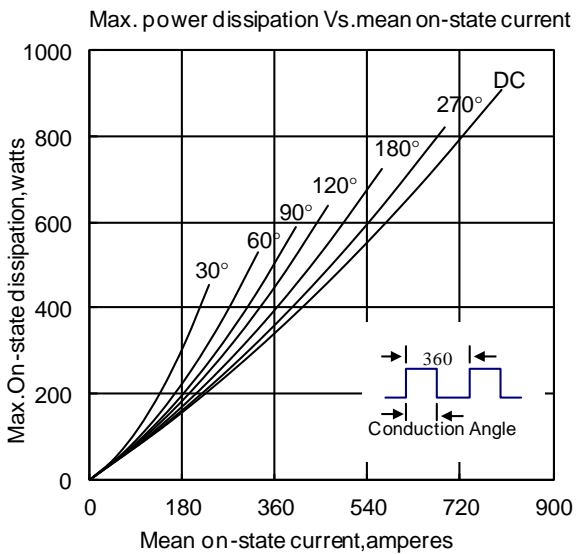

Fig5

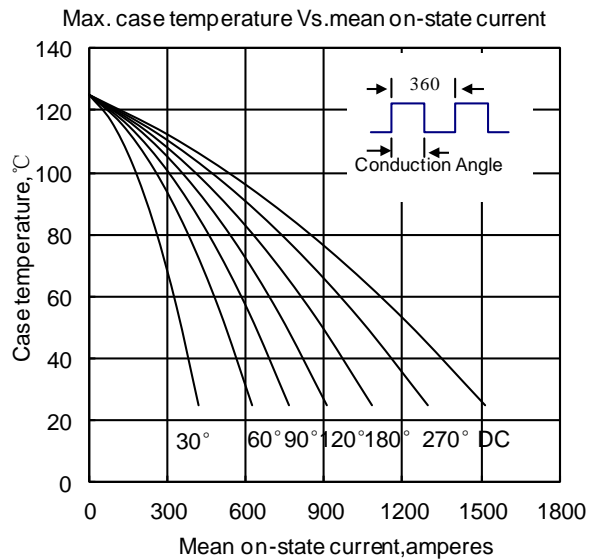

Fig6

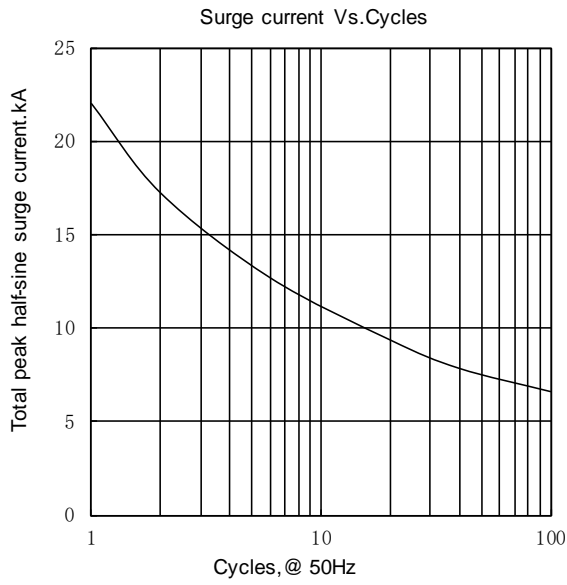

Fig.7

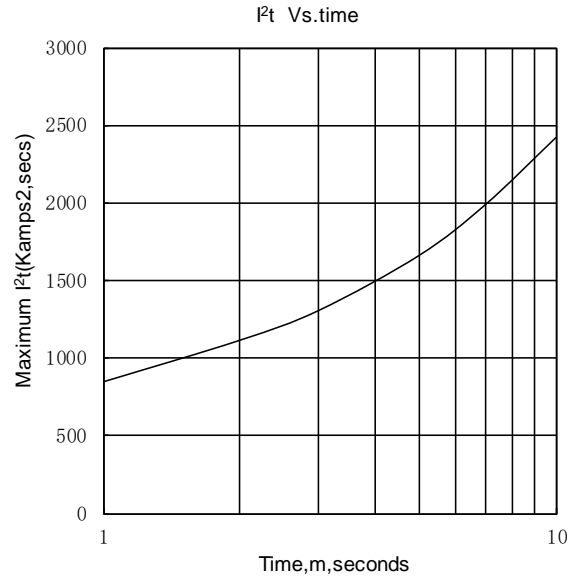

Fig.8

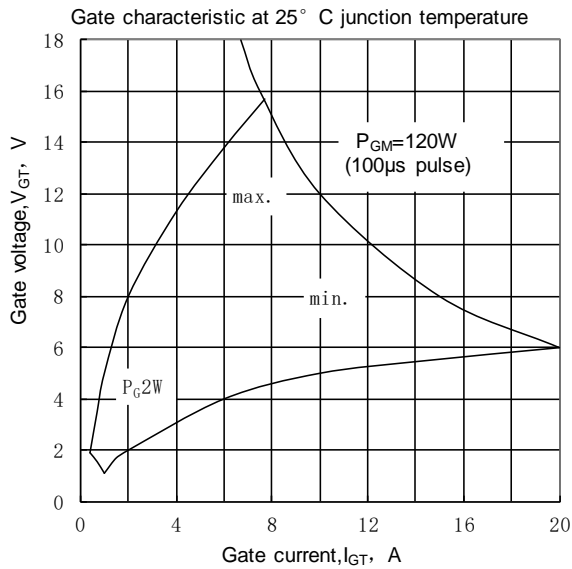

Fig.9

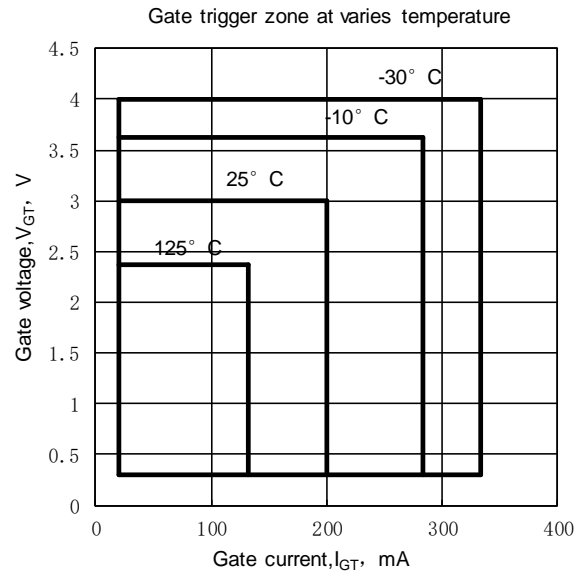

Fig.10

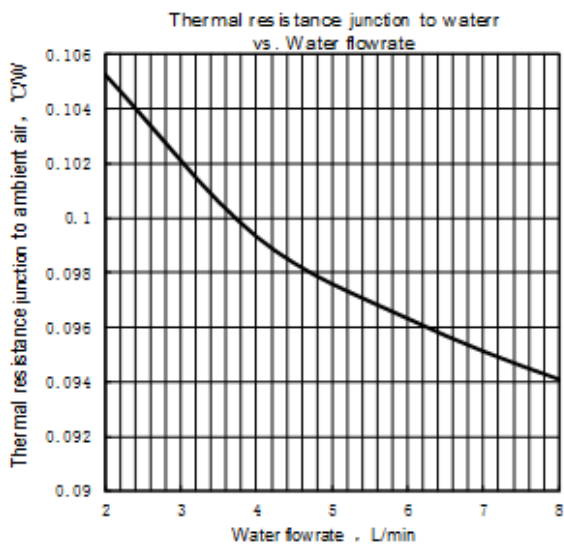

Fig.11

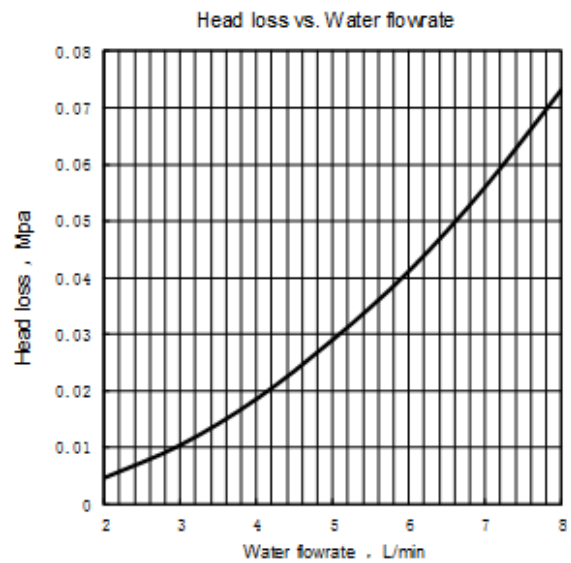
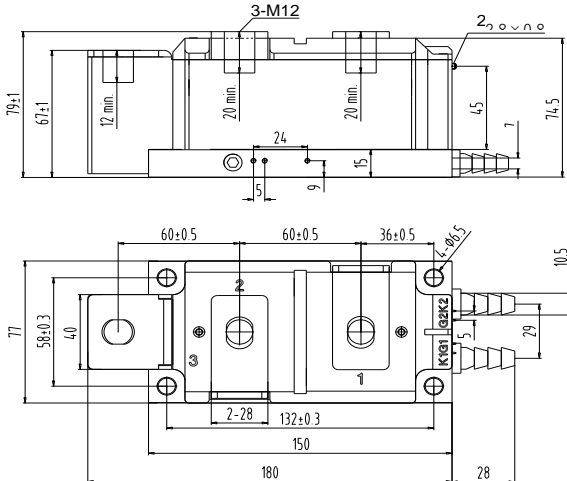

Fig.12



MD800T**W

MR800T**W

MC800T**W

