

Features:

- Isolated mounting base 3000V~
- Pressure contact technology with Increased power cycling capability
- Space and weight saving

Typical Applications:

- AC/DC Motor drives
- Various rectifiers
- DC supply for PWM inverter

V_{DSM}, V_{RSM}	V_{DRM}, V_{RRM}	品名
2100V	2000V	Mx800T200W
2300V	2200V	Mx800T220W
2600V	2500V	Mx800T250W

SYMBOL	CHARACTERISTIC	TEST CONDITIONS	$T_J(^{\circ}C)$	VALUE			UNIT
				Min.	Typ.	Max.	
$I_{T(AV)}$	Mean on-state current	180° half sine wave 50Hz Single side cooled, $T_{HS}=55^{\circ}C$	125			800	A
$I_{T(RMS)}$	RMS on-state current					1256	A
I_{DRM} I_{RRM}	Repetitive peak current	at V_{DRM} at V_{RRM}	125			50	mA
I_{TSM}	Surge on-state current	$V_R=60\%V_{RRM}$, $t=10ms$ half sine	125			16.0	kA
I^2t	I^2t for fusing coordination		125			1280	10^3A^2s
V_{TO}	Threshold voltage		125			0.98	V
r_T	On-state slope resistance					0.35	mΩ
V_{TM}	Peak on-state voltage	$I_{TM}=2400A$	25			2.35	V
dv/dt	Critical rate of rise of off-state voltage	$V_{DM}=67\%V_{DRM}$	125			1000	V/μs
di/dt	Critical rate of rise of on-state current	Gate source 1.5A $t_r \leq 0.5\mu s$ Repetitive	125			200	A/μs
I_{GT}	Gate trigger current	$V_A=12V$, $I_A=1A$	25	30		200	mA
V_{GT}	Gate trigger voltage			0.8		3.0	V
I_H	Holding current			10		200	mA
I_L	Latching current					1000	mA
V_{GD}	Non-trigger gate voltage	$V_{DM}=67\%V_{DRM}$	125			0.20	V
$R_{th(j-c)}$	Thermal resistance Junction to case	D.C. Single side cooled per chip				0.050	$^{\circ}C/W$
$R_{th(c-h)}$	Thermal resistance case to heatsink	D.C. Single side cooled per chip				0.024	$^{\circ}C/W$
V_{iso}	Isolation voltage	50Hz, R.M.S, $t=1min$, $I_{iso}:1mA(MAX)$		3000			V
F_m	Terminal connection torque(M12)			12.0		16.0	N·m
	Mounting torque(M8)			10.0		12.0	N·m
T_{vj}	Junction temperature			-40		125	$^{\circ}C$
T_{stg}	Stored temperature			-40		125	$^{\circ}C$
W_t	Weight				3230		g
Outline	M15						

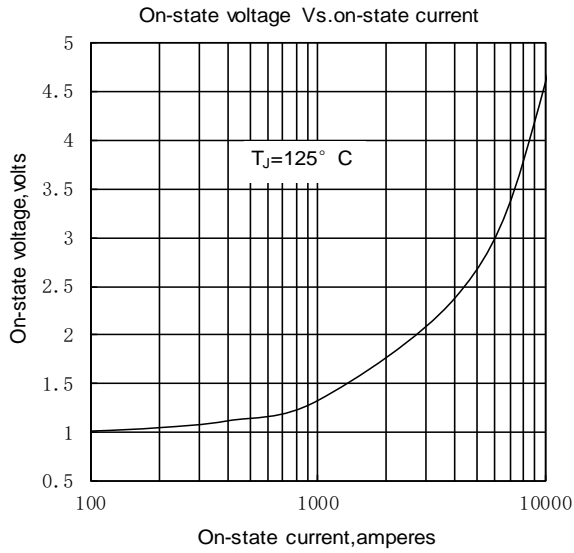

Fig.1

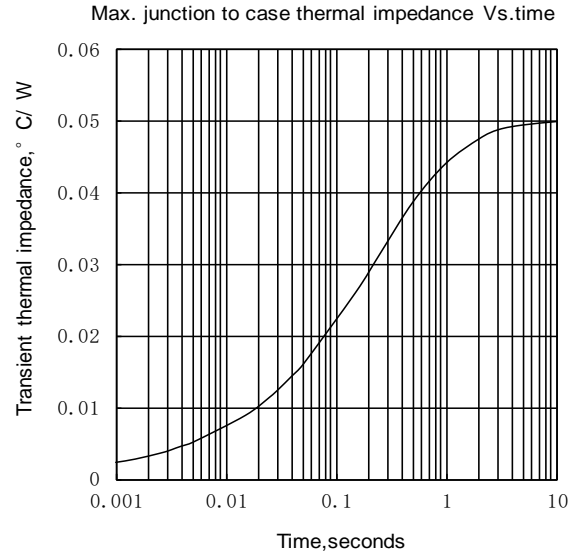

Fig.2

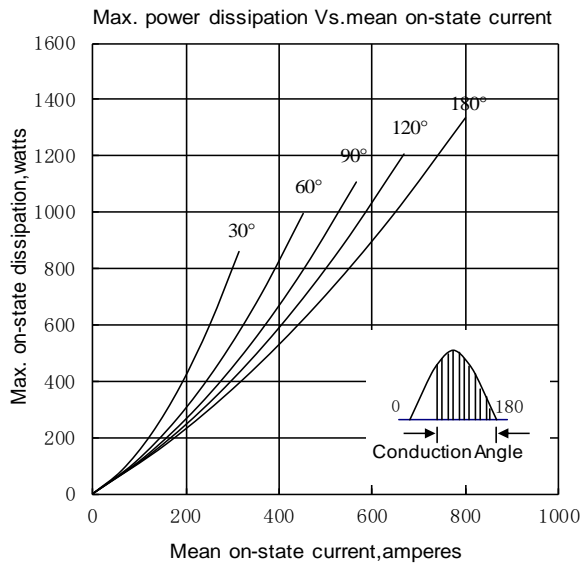

Fig.3

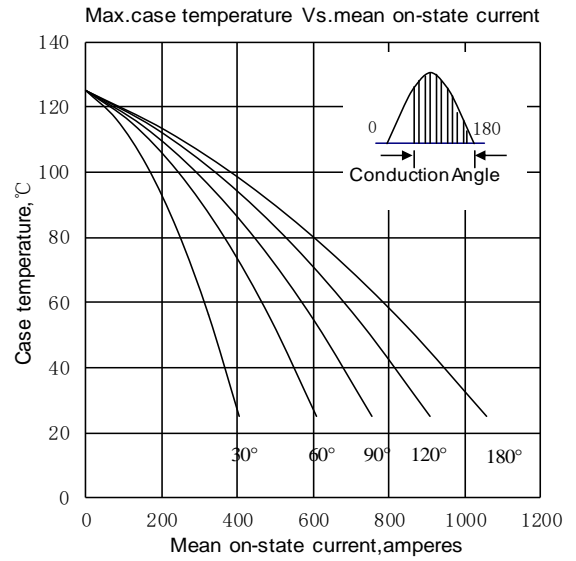

Fig.4

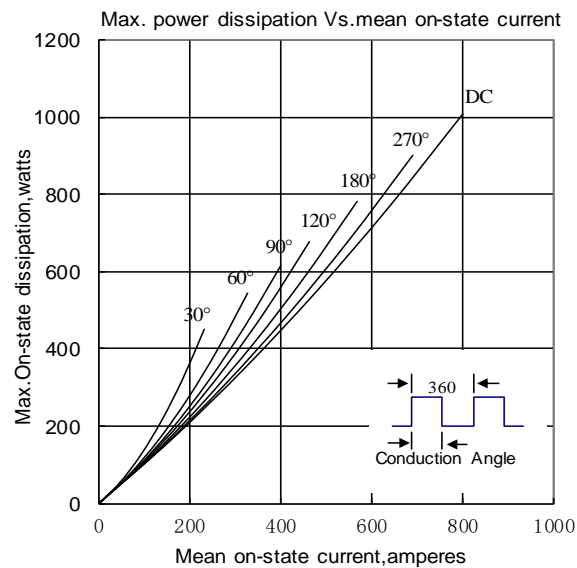

Fig.5

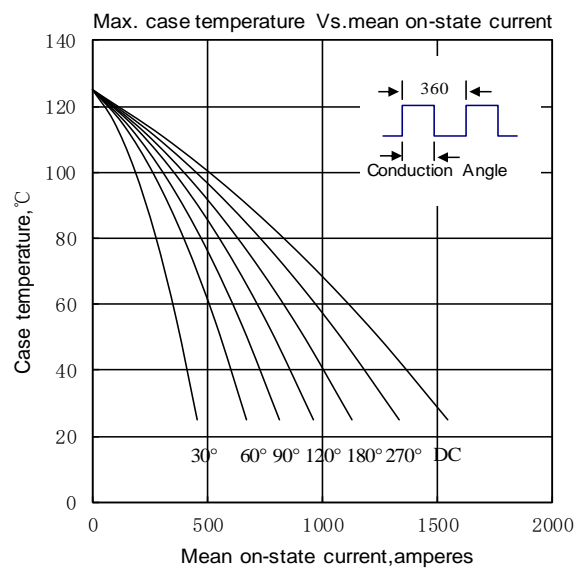

Fig.6

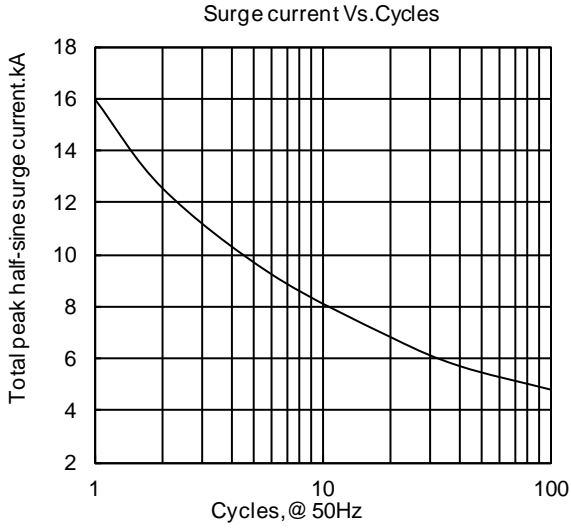

Fig. 7

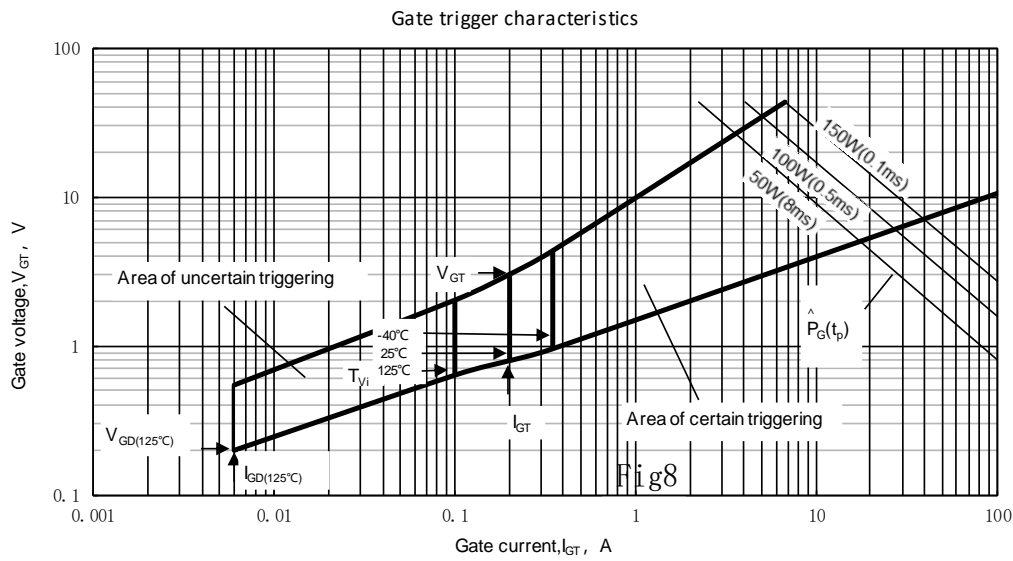
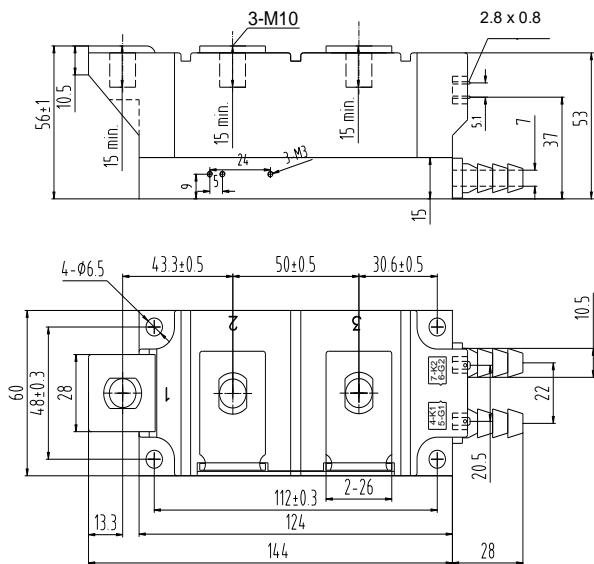

Fig8



MD800T**W

MR800T**W

MC800T**W

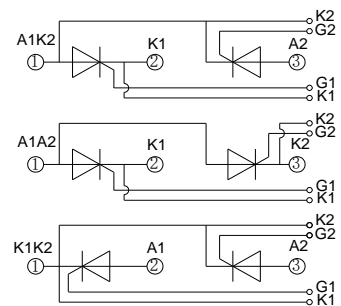

Unmarked dimensional tolerance : ±0.5mm

Nips reserves the right to change specifications without notice.