

**Features :**

- Isolated mounting base 3000V~
- Pressure contact technology with Increased power cycling capability
- Space and weight saving

**Typical Applications**

- Various rectifiers
- DC supply for PWM inverter

V <sub>RSM</sub>	V <sub>RRM</sub>	品名
900V	800V	Mx90D80
1100V	1000V	Mx90D100
1300V	1200V	Mx90D120
1500V	1400V	Mx90D140
1700V	1600V	Mx90D160
1900V	1800V	Mx90D180

SYMBOL	CHARACTERISTIC	TEST CONDITIONS	T <sub>j</sub> (°C)	VALUE			UNIT
				Min	Type	Max	
I <sub>F(AV)</sub>	Mean forward current	180° half sine wave 50Hz Single side cooled, T <sub>c</sub> =100°C	150			90	A
I <sub>F(RMS)</sub>	RMS forward current		150			141	A
I <sub>RRM</sub>	Repetitive peak current	at V <sub>RRM</sub>	150			8	mA
I <sub>FSM</sub>	Surge forward current	10ms half sine wave V <sub>R</sub> =0.6V <sub>RRM</sub>	150			2.3	kA
I <sup>2</sup> t	I <sup>2</sup> t for fusing coordination					26	A <sup>2</sup> s*10 <sup>3</sup>
V <sub>FO</sub>	Threshold voltage		150			0.80	V
r <sub>F</sub>	Forward slope resistance					1.70	mΩ
V <sub>FM</sub>	Peak forward voltage	I <sub>FM</sub> =270A	25			1.38	V
R <sub>th(j-c)</sub>	Thermal resistance Junction to case	At 180° sine Single side cooled per chip				0.47	°C/W
R <sub>th(c-h)</sub>	Thermal resistance case to heatsink	At 180° sine Single side cooled per chip				0.20	°C/W
V <sub>iso</sub>	Isolation voltage	50Hz, R.M.S, t=1min, I <sub>iso</sub> :1mA(max)		3000			V
F <sub>m</sub>	Terminal connection torque(M5)			2.4		3.0	N·m
	Mounting torque(M6)				6		N·m
T <sub>vj</sub>	Junction temperature			-40		150	°C
T <sub>stg</sub>	Stored temperature			-40		125	°C
W <sub>t</sub>	Weight				170		g
Outline	M01						

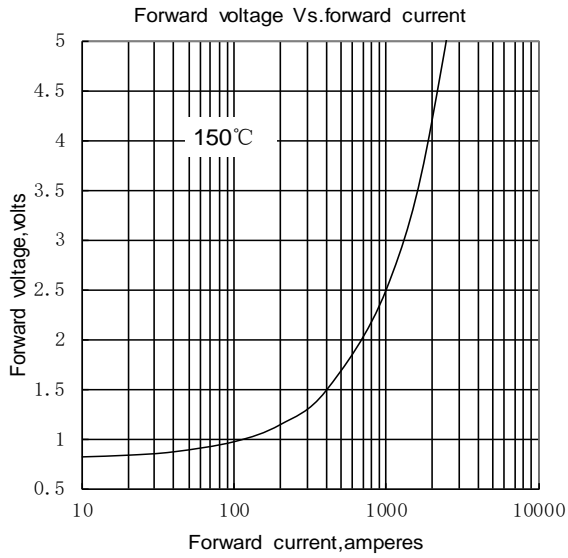

Fig.1

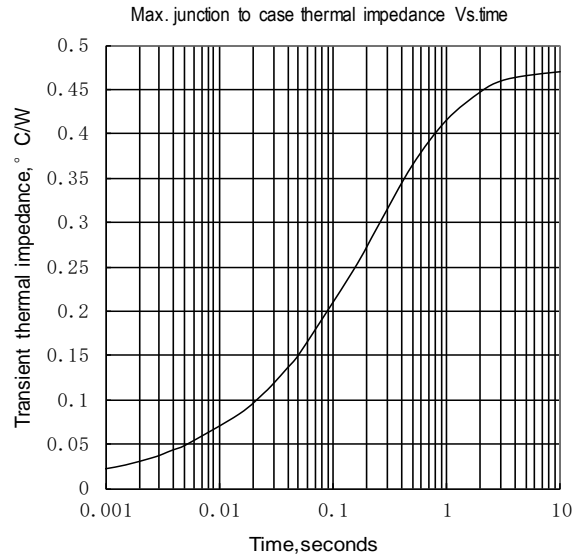

Fig.2

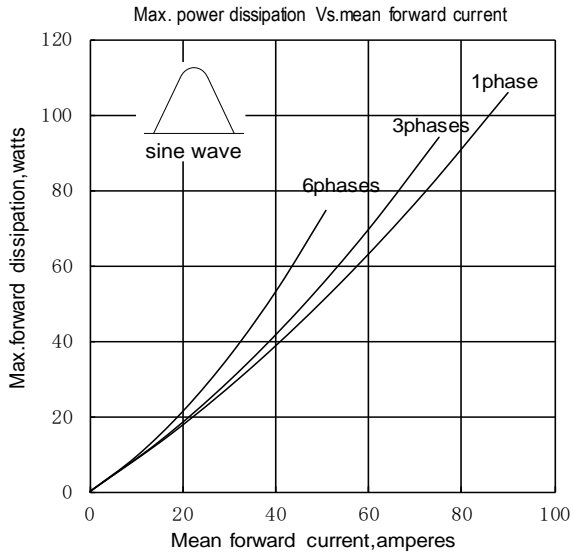

Fig.3

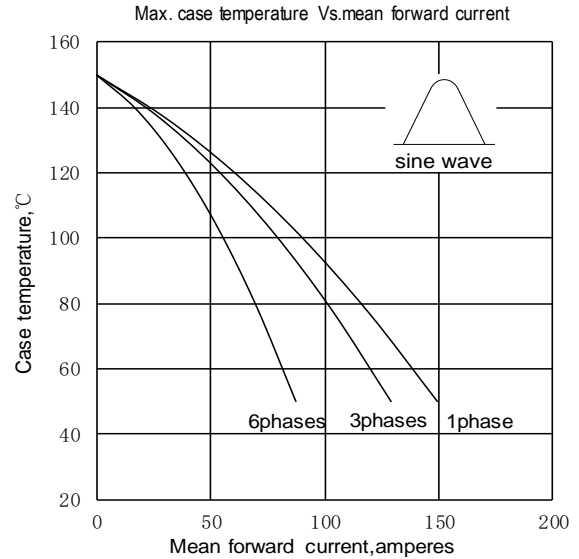

Fig.4

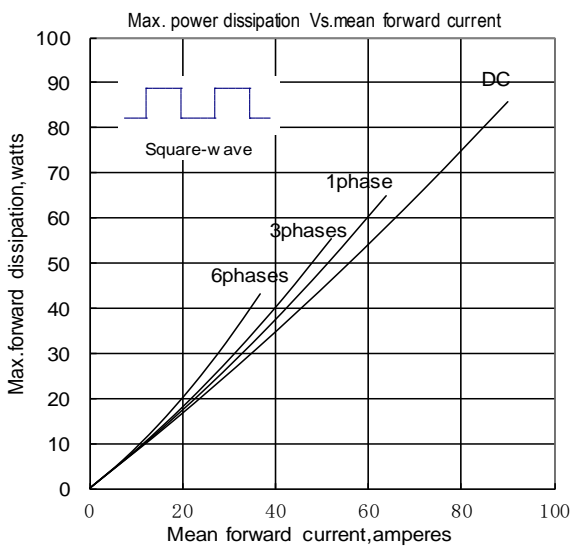

Fig.5

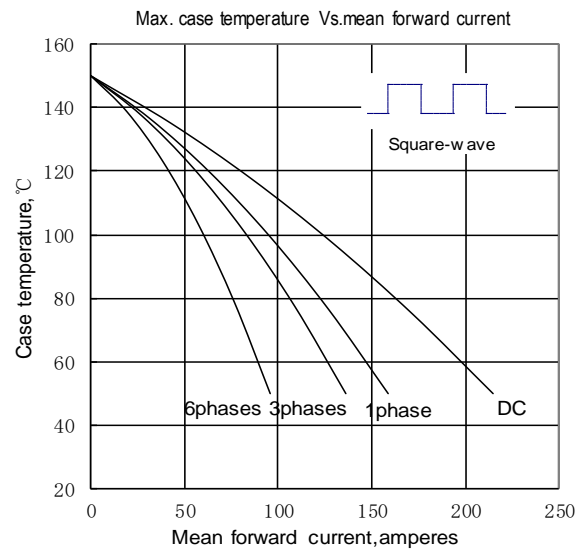

Fig.6

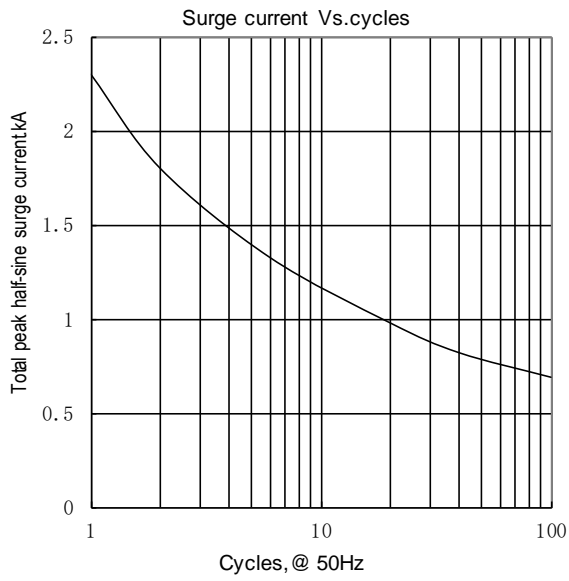

Fig.7

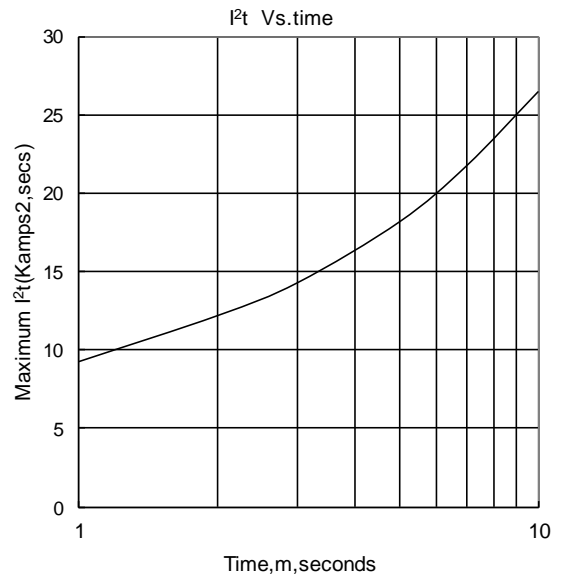
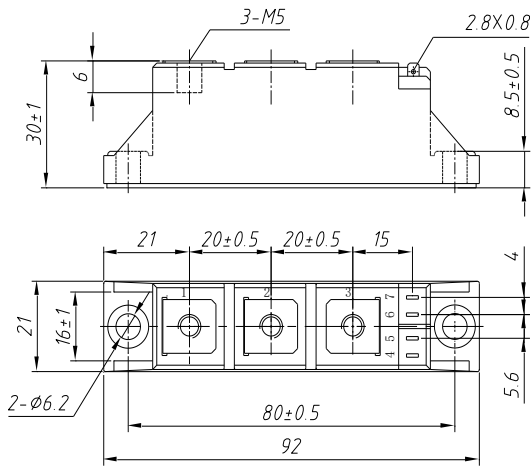
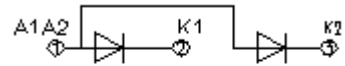

Fig.8



MR90D\*\*



MC90D\*\*

