

Features :

- Isolated mounting base 3000V~
- Pressure contact technology with Increased power cycling capability
- Space and weight saving

Typical Applications

- AC/DC Motor drives
- DC supply for PWM inverter

V _{RSM}	V _{RRM}	品名
2100V	2000V	Mx90D200
2300V	2200V	Mx90D220
2600V	2500V	Mx90D250

SYMBOL	CHARACTERISTIC	TEST CONDITIONS	T _j (°C)	VALUE			UNIT
				Min.	Typ.	Max.	
I _{F(AV)}	Mean forward current	180° half sine wave 50Hz Single side cooled, T _C =100°C	150			90	A
I _{F(RMS)}	RMS forward current		150			141	A
I _{RRM}	Repetitive peak current	at V _{RRM}	150			8	mA
I _{FSM}	Surge forward current	10ms half sine wave V _R =0.6V _{RRM}	150			2.3	kA
I ² t	I ² t for fusing coordination					26	A ² s*10 ³
V _{FO}	Threshold voltage		150			0.85	V
r _F	Forward slope resistance					1.88	mΩ
V _{FM}	Peak forward voltage	I _{FM} =270A	25			1.43	V
R _{th(j-c)}	Thermal resistance Junction to case	D.C.: Single side cooled per chip				0.45	°C/W
R _{th(c-h)}	Thermal resistance case to heatsink	D.C.: Single side cooled per chip				0.20	°C/W
V _{iso}	Isolation voltage	50Hz,R.M.S,t=1min,I _{iso} :1mA(max)		3000			V
F _m	Terminal connection torque(M5)			2.4		3.0	N·m
	Mounting torque(M6)				6.0		N·m
T _{vj}	Junction temperature			-40		150	°C
T _{stg}	Stored temperature			-40		125	°C
W _t	Weight				170		g
Outline	M01						

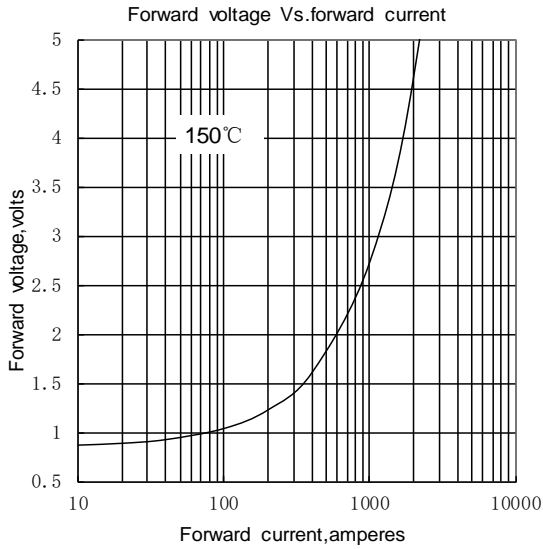

Fig.1

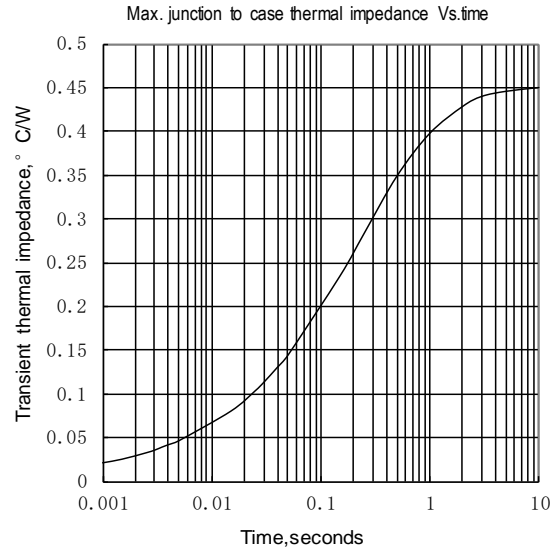

Fig.2

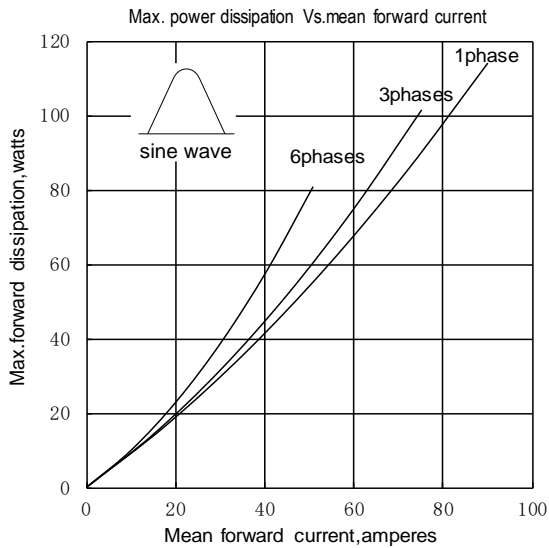

Fig.3

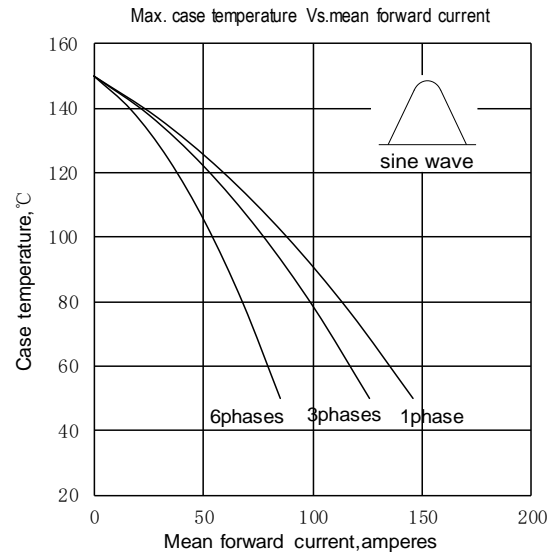

Fig.4

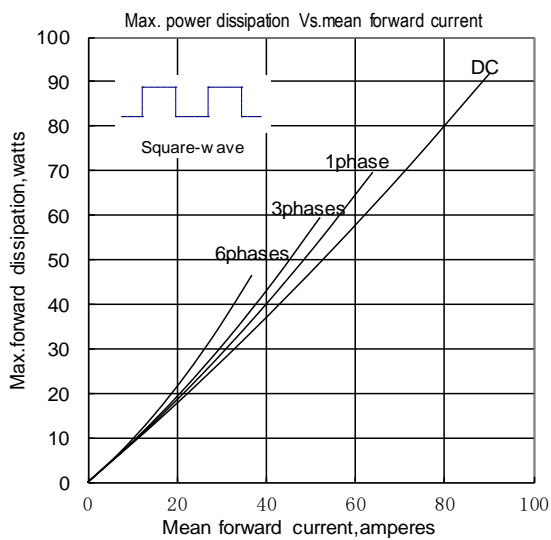

Fig.5

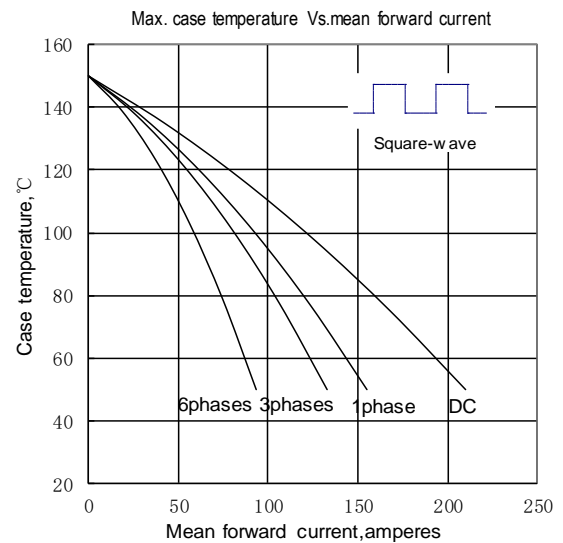

Fig.6

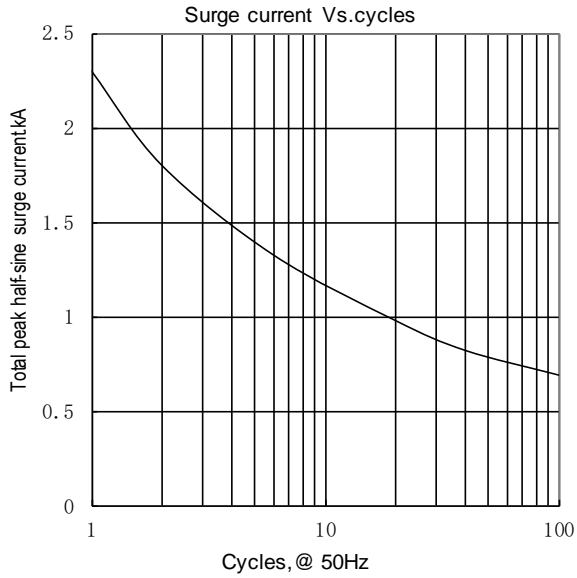
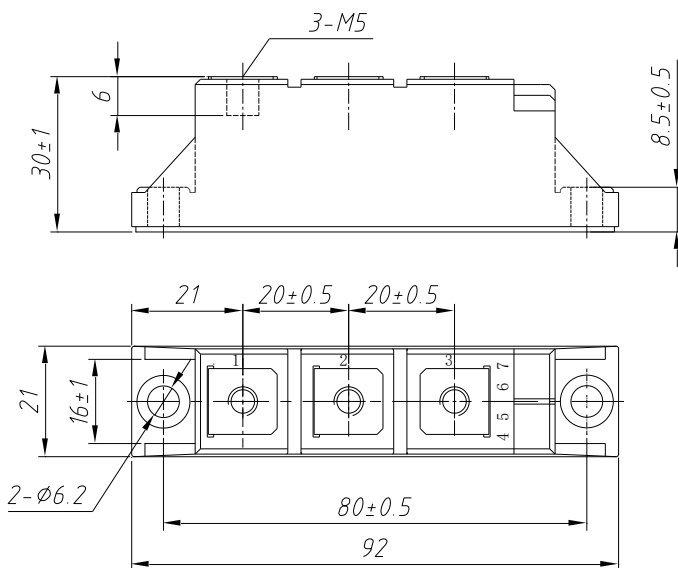
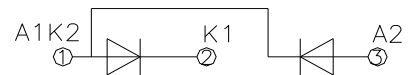

Fig.7



Unmarked dimensional tolerance : ±0.5mm

MD90D**



MR90D**

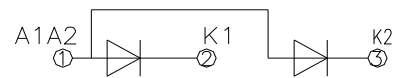

MC90D**

