

Features

- Low forward voltage drop
- High reverse voltage
- Hermetic metal cases with ceramic insulators

Typical Applications

- All purpose high power rectifier diodes
- High power resistance welding equipment
- Non-controllable and half-controllable rectifiers
- Controlled rectifiers

$I_{F(AV)}$	3290 A
V_{RRM}	4300~5000 V
I_{FSM}	35 kA
I^2t	6125 10³A²S

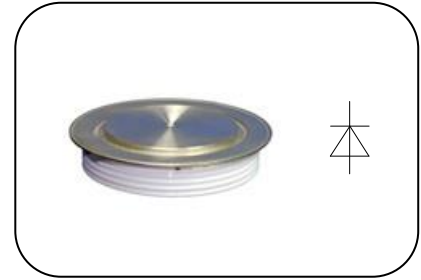

SYMBOL	CHARACTERISTIC	TEST CONDITIONS		T _j (°C)	VALUE			UNIT
					Min	Type	Max	
$I_{F(AV)}$	Mean forward current	180° half sine wave 50Hz Double side cooled,	T _C =85°C	150			3290	A
V_{RRM}	Repetitive peak reverse voltage	tp=10ms		150	4300		5000	V
I_{RRM}	Repetitive peak current	at V _{RRM}		150			200	mA
I_{FSM}	Surge forward current	10ms half sine wave, V _R =0.6V _{RRM}		150			35	kA
I^2t	I ² t for fusing coordination						6125	A ² s*10 ³
V_{FO}	Threshold voltage			150			0.88	V
r_F	Forward slope resistance						0.12	mΩ
V_{FM}	Peak on-state voltage	I _{FM} =4000A, F=40kN		25			1.50	V
Q_{rr}	Recovery charge	I _{FM} =2000A, tp=2000μs, di/dt=-20A/μs, V _R =50V		150		12000		μC
$R_{th(j-c)}$	Thermal resistance Junction to case	DC· double side cooled Clamping force 40kN					0.010	°C /W
$R_{th(c-h)}$	Thermal resistance case to heat sink						0.003	
F_m	Mounting force				35		47	kN
T_{stg}	Stored temperature				-40		150	°C
W_t	Weight					1100		g
Outline	P46							

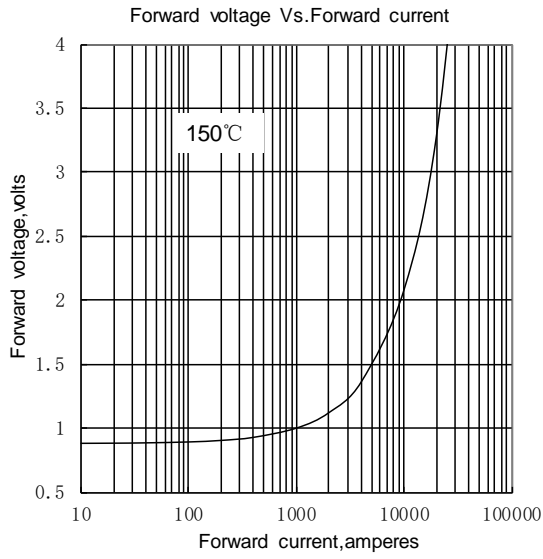

Fig1

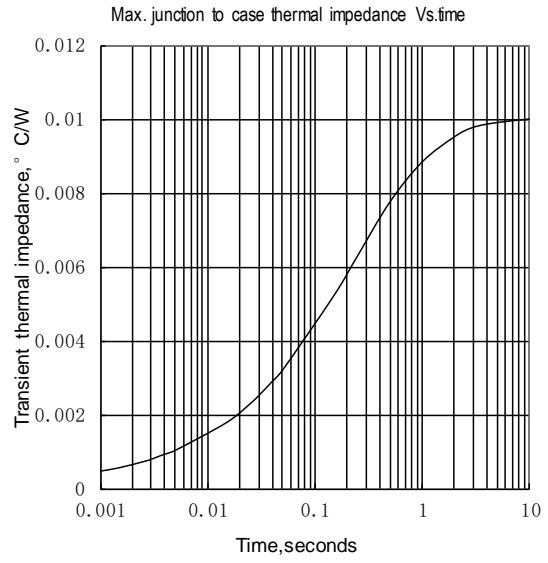

Fig2

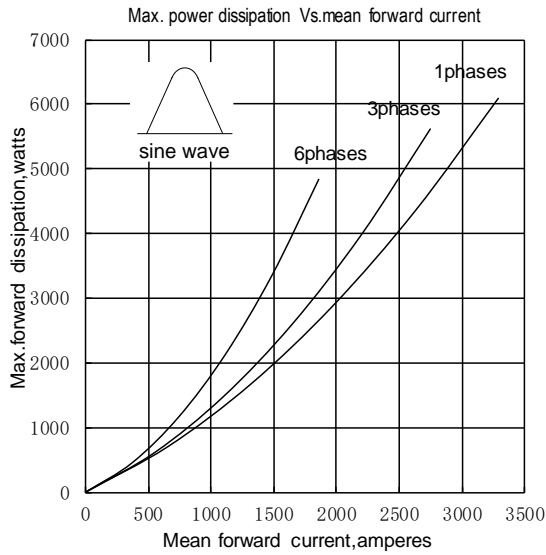

Fig3

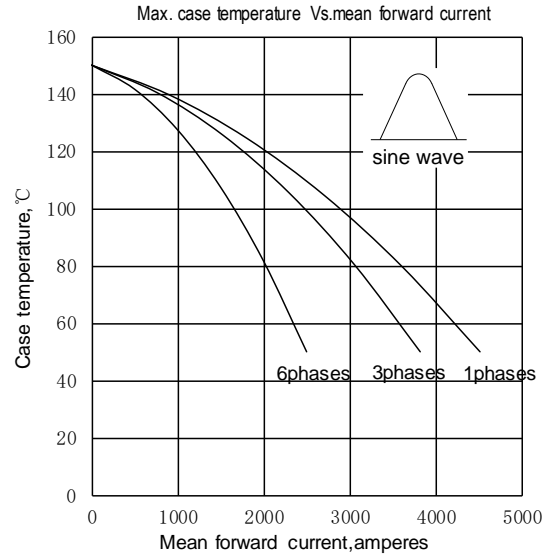

Fig4

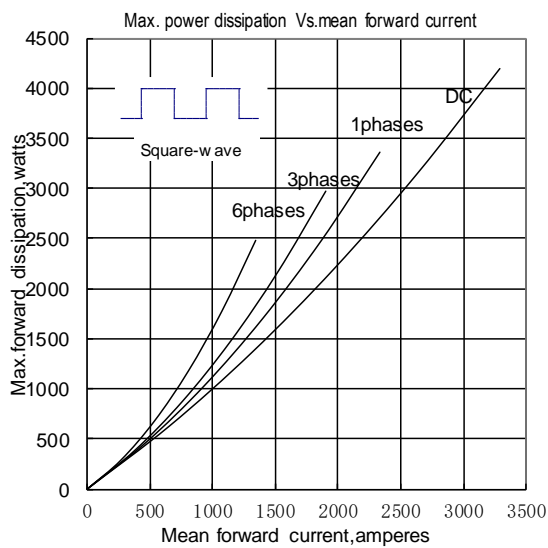

Fig5

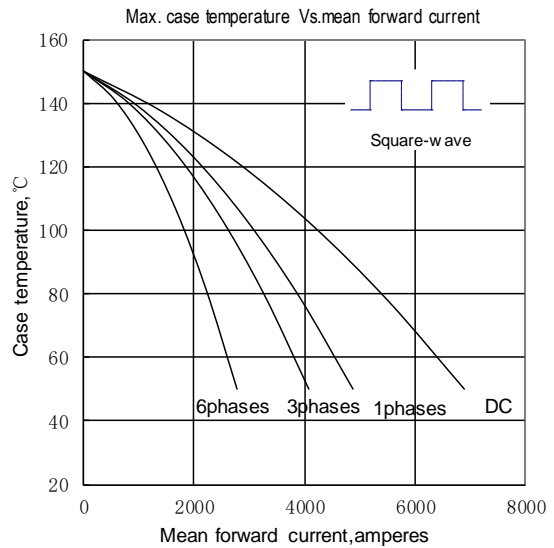

Fig6

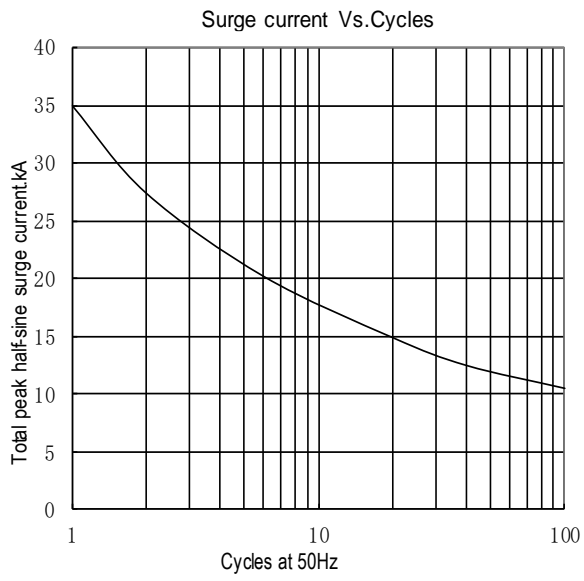
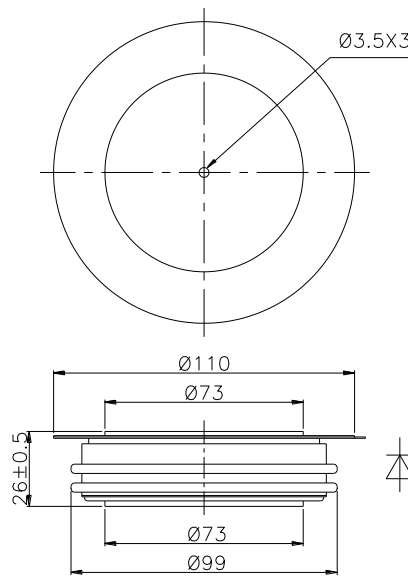

Fig.7



Nlps reserves the right to change specifications without notice.