

### Features

- Low forward voltage drop
- High reverse voltage
- Hermetic metal cases with ceramic insulators

### Typical Applications

- All purpose high power rectifier diodes
- High power resistance welding equipment
- Non-controllable and half-controllable rectifiers
- Controlled rectifiers

**$I_{F(AV)}$**       **3520A**  
 **$V_{RRM}$**         **1100~2000 V**  
 **$I_{FSM}$**           **34 kA**  
 **$I^2t$**              **5780 10<sup>3</sup>A<sup>2</sup>S**



SYMBOL	CHARACTERISTIC	TEST CONDITIONS		T <sub>j</sub> (°C)	VALUE			UNIT
					Min	Type	Max	
$I_{F(AV)}$	Mean forward current	180° half sine wave 50Hz Double side cooled,	T <sub>C</sub> =85°C	175			3520	A
$V_{RRM}$	Repetitive peak reverse voltage	tp=10ms		175	1100		2000	V
$I_{RRM}$	Repetitive peak current	At $V_{RRM}$		175			120	mA
$I_{FSM}$	Surge forward current	10ms half sine wave		175			34	kA
$I^2t$	$I^2t$ for fusing coordination	$V_R=0.6V_{RRM}$					5780	A <sup>2</sup> s*10 <sup>3</sup>
$V_{FO}$	Threshold voltage			175			0.73	V
$r_F$	Forward slope resistance						0.10	mΩ
$V_{FM}$	Peak forward voltage	$I_{FM}=4000A, F=28kN$		175			1.13	V
$Q_{rr}$	Recovery charge	$I_{FM}=2000A, tp=2000\mu s, di/dt=-20A/\mu s, V_R=50V$		175		5000		μC
$R_{th(j-c)}$	Thermal resistance Junction to case	DC: double side cooled Clamping force 28kN					0.016	°C /W
$R_{th(c-h)}$	Thermal resistance case to heat sink						0.004	
$F_m$	Mounting force				21		30	kN
$T_{stg}$	Stored temperature				-40		175	°C
$W_t$	Weight					640		g
Outline	P43							

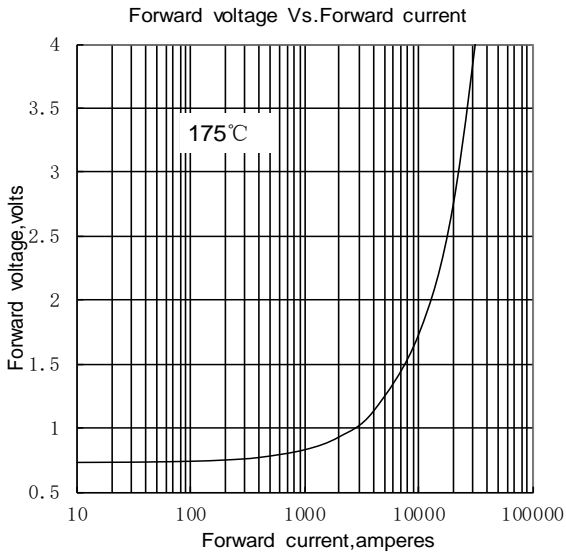

Fig.1

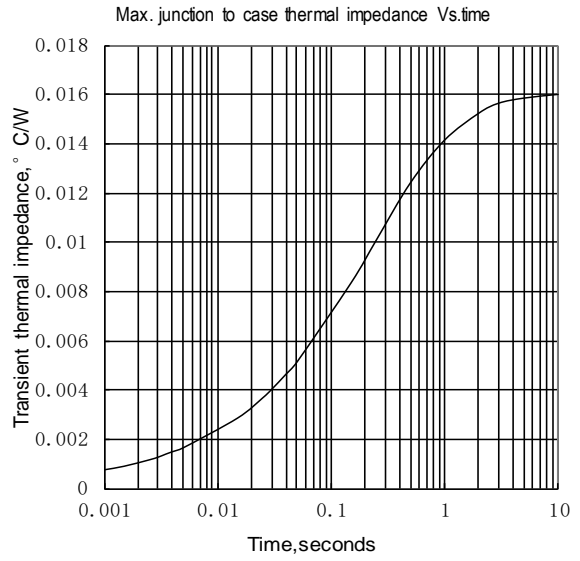

Fig.2

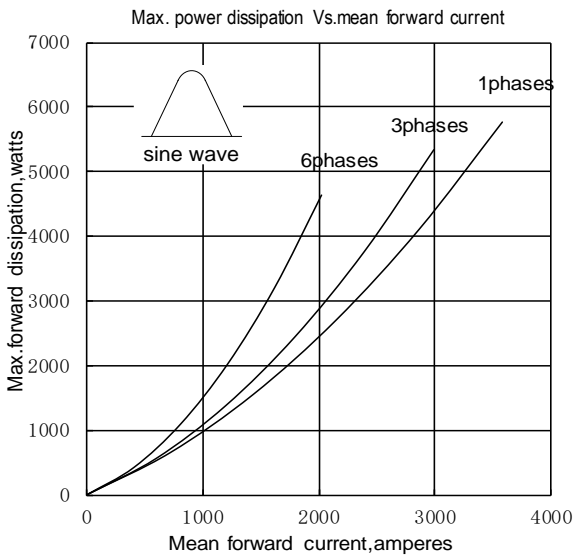

Fig.3

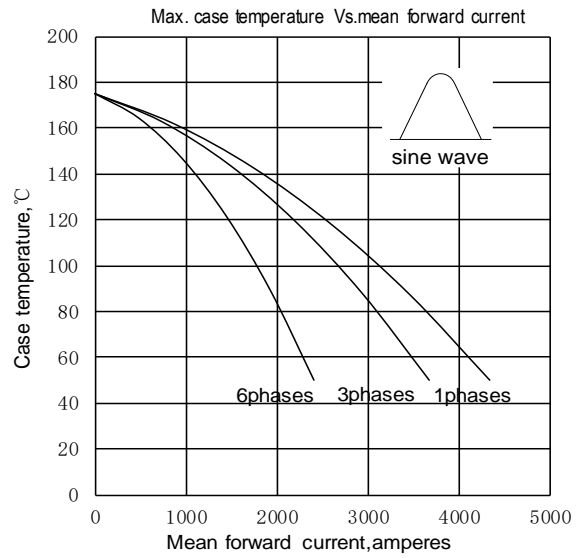

Fig.4

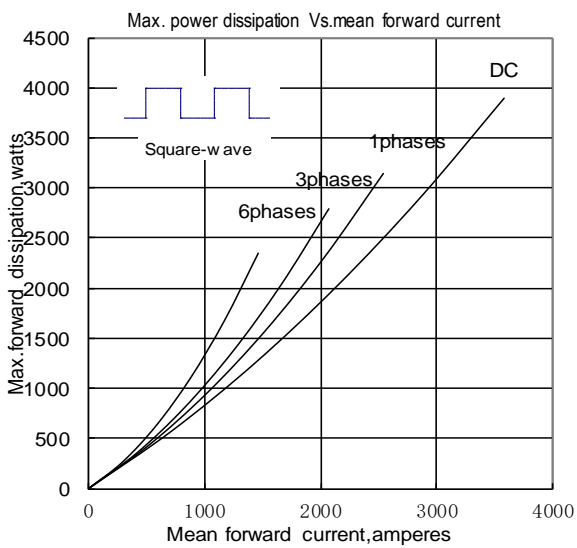

Fig.5

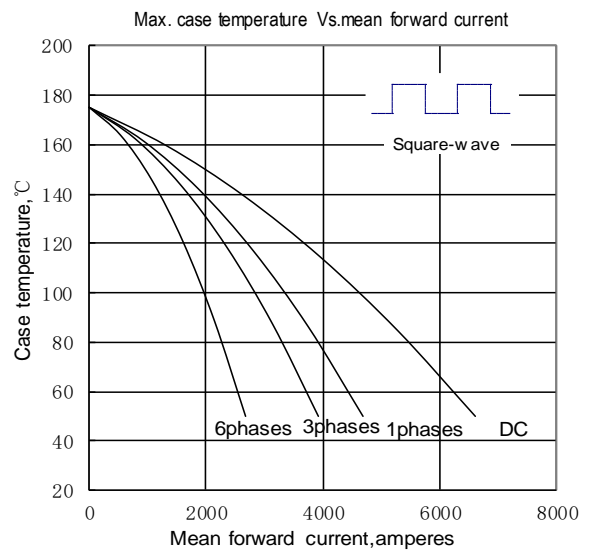

Fig.6

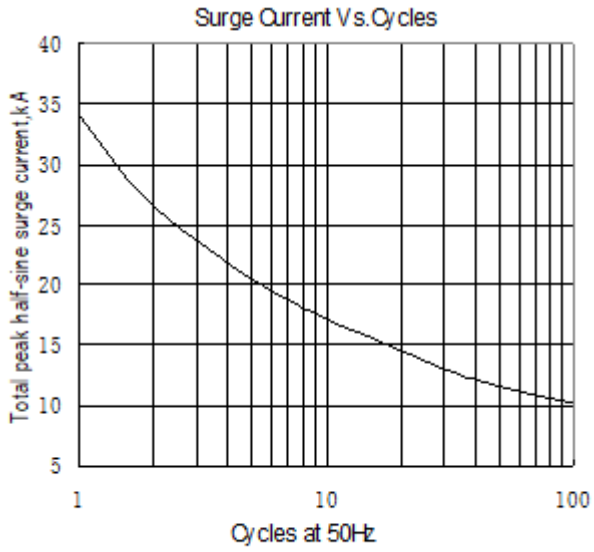
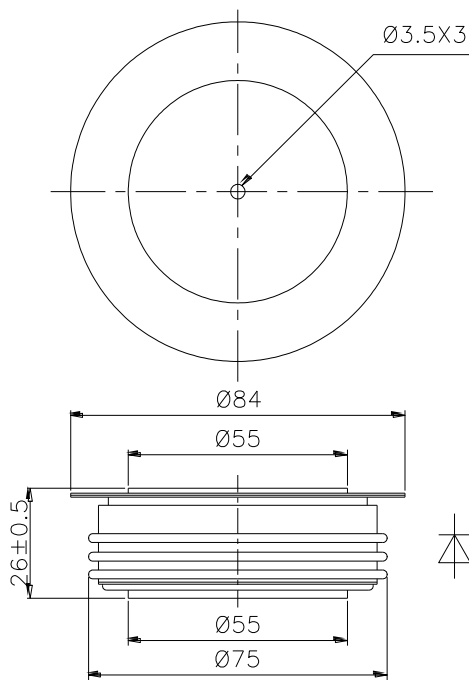

Fig. 7



Nlps reserves the right to change specifications without notice.