

**Features :**

- Isolated mounting base 3000V~
- Solder joint technology with increased power cycling capability
- Space and weight saving

**Typical Applications**

- AC/DC Motor drives
- Various rectifiers
- DC supply for PWM inverter

$V_{DSM}, V_{RSM}$	$V_{DRM}, V_{RRM}$	品名
900V	800V	MD135T80S
1100V	1000V	MD135T100S
1300V	1200V	MD135T120S
1500V	1400V	MD135T140S
1700V	1600V	MD135T160S
1900V	1800V	MD135T180S

SYMBOL	CHARACTERISTIC	TEST CONDITIONS	$T_j(^{\circ}C)$	VALUE			UNIT
				Min.	Typ.	Max.	
$I_{T(AV)}$	Mean on-state current	180° half sine wave 50Hz Single side cooled, $T_c=85^{\circ}C$	125			135	A
$I_{T(RMS)}$	RMS on-state current		125			212	A
$I_{DRM}$ $I_{RRM}$	Repetitive peak current	at $V_{DRM}$ at $V_{RRM}$	125			35	mA
$I_{TSM}$	Surge on-state current	10ms half sine wave $V_R=60\%V_{RRM}$	125			3.5	kA
$I^2t$	$I^2t$ for fusing coordination					61.3	$A^2s \cdot 10^3$
$V_{TO}$	Threshold voltage		125			0.95	V
$r_T$	On-state slope resistance					1.50	m $\Omega$
$V_{TM}$	Peak on-state voltage	$I_{TM}=410A$	25			1.60	V
$dv/dt$	Critical rate of rise of off-state voltage	$V_{DM}=67\%V_{DRM}$	125			1000	V/ $\mu s$
$di/dt$	Critical rate of rise of on-state current	Gate source 1.5A $t_r \leq 0.5\mu s$ Repetitive	125			200	A/ $\mu s$
$I_{GT}$	Gate trigger current	$V_A=12V, I_A=1A$	25	30		200	mA
$V_{GT}$	Gate trigger voltage			0.6		2.5	V
$I_H$	Holding current			10		250	mA
$V_{GD}$	Non-trigger gate voltage	$V_{DM}=67\%V_{DRM}$	125	0.2			V
$R_{th(j-c)}$	Thermal resistance Junction to case	D.C. Single side cooled per chip				0.18	$^{\circ}C/W$
$R_{th(c-h)}$	Thermal resistance case to heatsink	D.C. Single side cooled per chip				0.08	$^{\circ}C/W$
$V_{iso}$	Isolation voltage	50Hz, R.M.S, $t=1min, I_{iso}: 1mA(MAX)$		3000			V
$F_m$	Terminal connection torque(M6)			3.5		5.0	N-m
	Mounting torque(M6)			3.5		5.0	N-m
$T_{stg}$	Stored temperature			-40		125	$^{\circ}C$
$W_t$	Weight				150		g
Outline	M17						

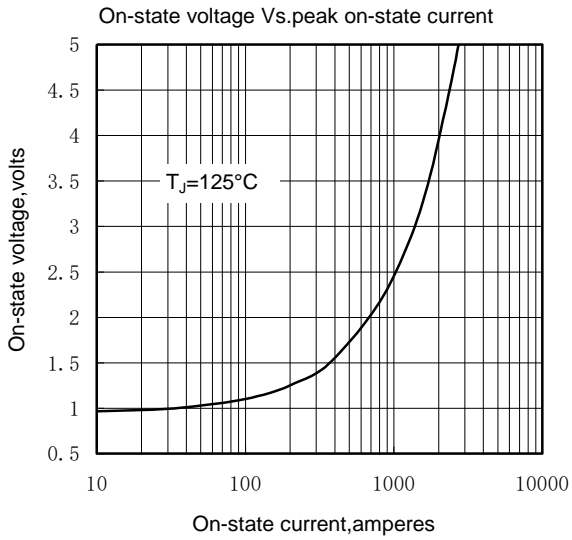

Fig1

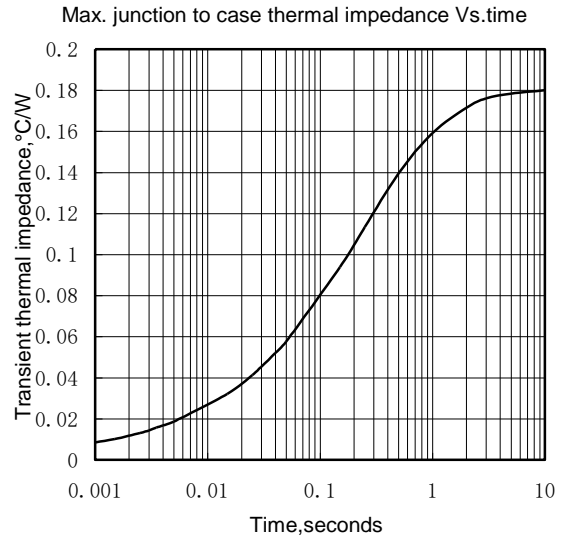

Fig2

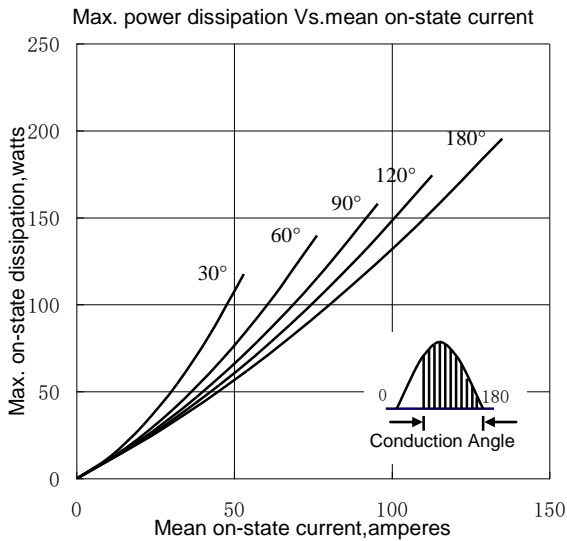

Fig3

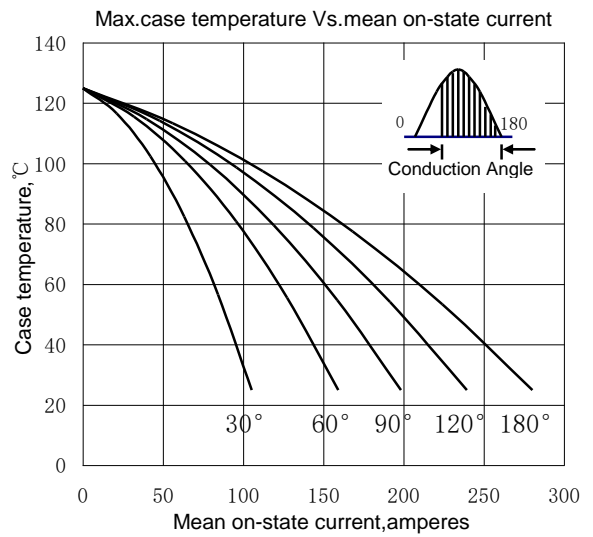

Fig4

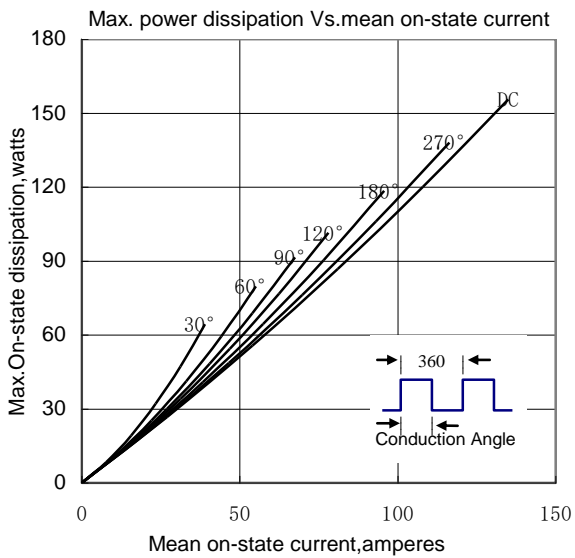

Fig5

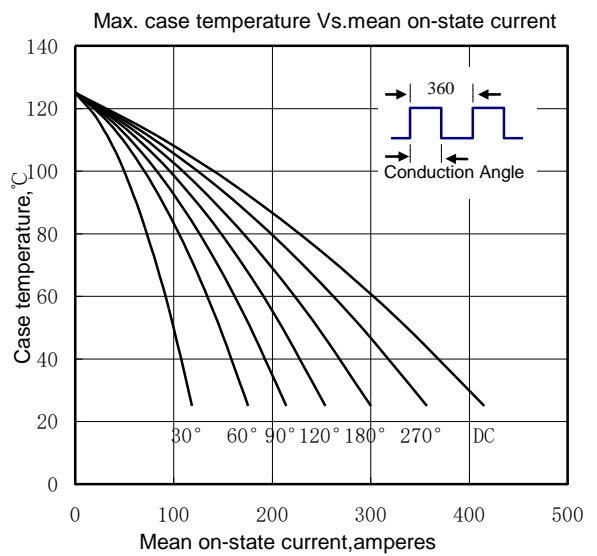

Fig6

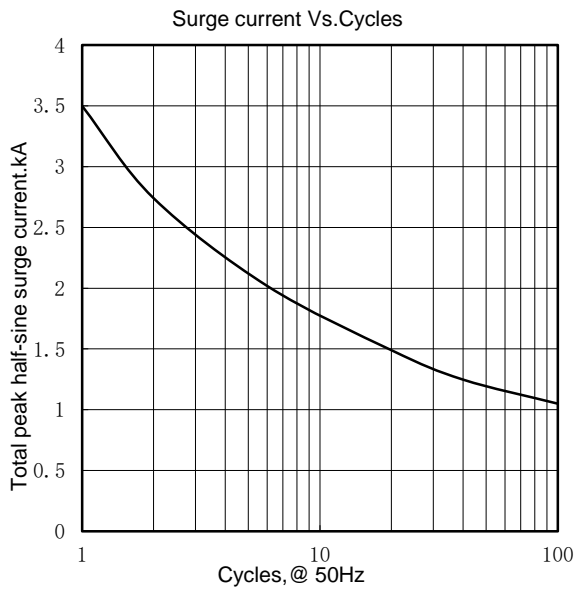

Fig7

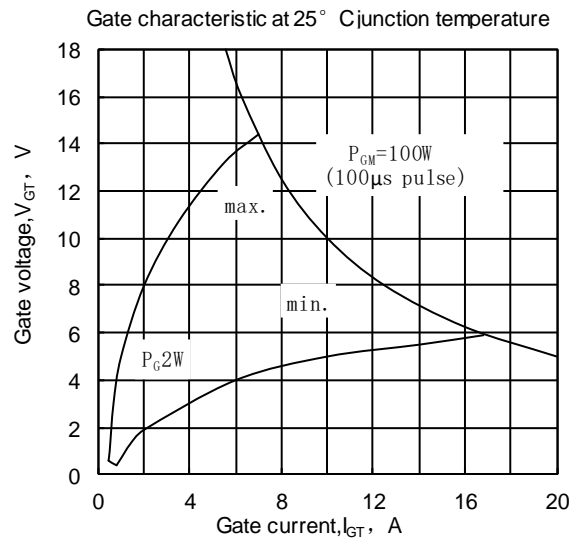

Fig8

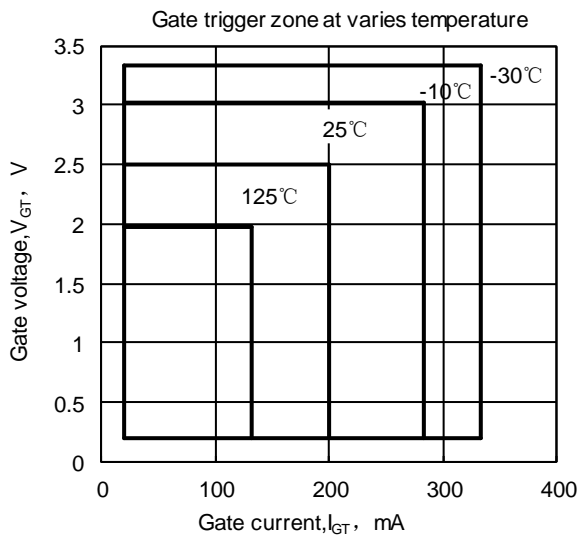
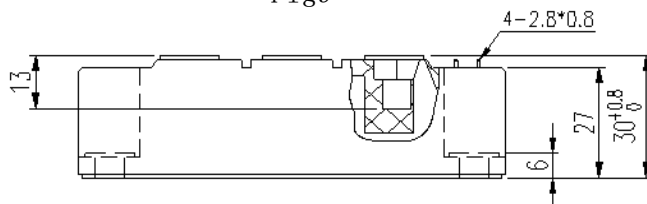
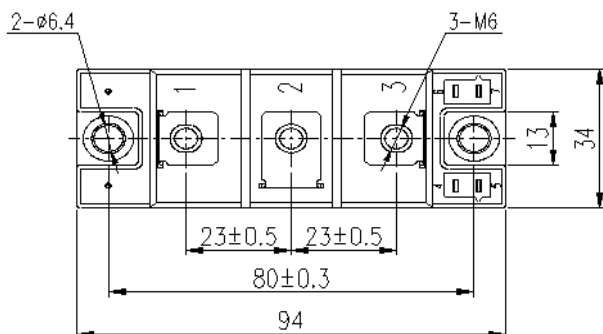
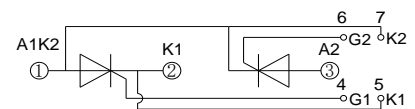

Fig9



MD135T\*\*S



Unmarked dimensional tolerance : ±0.5mm

Nlps reserves the right to change specifications without notice.