

**Features :**

- Isolated mounting base 4000V~
- Pressure contact technology with Increased power cycling capability
- Space and weight saving

**Typical Applications**

- AC/DC Motor drives
- Various rectifiers
- DC supply for PWM inverter

V <sub>DSM</sub> ,V <sub>RSM</sub>	V <sub>DRM</sub> ,V <sub>RRM</sub>	品名
2700V	2600V	Mx400T260W
2900V	2800V	Mx400T280W
3100 V	3000 V	Mx400T300W
3300 V	3200 V	Mx400T320W
3500 V	3400 V	Mx400T340W
3700 V	3600 V	Mx400T360W

SYMBOL	CHARACTERISTIC	TEST CONDITIONS	T <sub>j</sub> (°C)	VALUE			UNIT
				Min.	Typ.	Max.	
I <sub>T(AV)</sub>	Mean on-state current	180° half sine wave 50Hz Single side water cooled, T <sub>c</sub> =55°C	125			400	A
I <sub>T(RMS)</sub>	RMS on-state current					628	A
I <sub>DRM</sub> I <sub>RRM</sub>	Repetitive peak current	at V <sub>DRM</sub> at V <sub>RRM</sub>	125			50	mA
I <sub>TSM</sub>	Surge on-state current	10ms half sine wave V <sub>R</sub> =60%V <sub>RRM</sub>	125			10.5	kA
I <sup>2</sup> t	I <sup>2</sup> t for fusing coordination					551	A <sup>2</sup> s*10 <sup>3</sup>
V <sub>TO</sub>	Threshold voltage		125			1.12	V
r <sub>T</sub>	On-state slope resistance					1.25	mΩ
V <sub>TM</sub>	Peak on-state voltage	I <sub>TM</sub> =1200A	25			2.85	V
dv/dt	Critical rate of rise of off-state voltage	V <sub>DM</sub> =67%V <sub>DRM</sub>	125			800	V/μs
di/dt	Critical rate of rise of on-state current	Gate source 1.5A t <sub>r</sub> ≤0.5μs Repetitive	125			100	A/μs
I <sub>GT</sub>	Gate trigger current	V <sub>A</sub> =12V, I <sub>A</sub> =1A	25	30		200	mA
V <sub>GT</sub>	Gate trigger voltage			0.8		3.0	V
I <sub>H</sub>	Holding current			10		200	mA
V <sub>GD</sub>	Non-trigger gate voltage	V <sub>DM</sub> =67%V <sub>DRM</sub>	125	0.2			V
R <sub>th(j-c)</sub>	Thermal resistance Junction to case	D.C. Single side cooled, per chip.				0.073	°C/W
R <sub>th(c-h)</sub>	Thermal resistance case to heat sink	D.C. Single side cooled, per chip.				0.040	°C/W
V <sub>iso</sub>	Isolation voltage	50Hz,R.M.S,t=1min,I <sub>iso</sub> :1mA(MAX)		4000			V
F <sub>m</sub>	Terminal connection torque(M10)				12.0		N·m
	Mounting torque(M6)				6.0		N·m
T <sub>vj</sub>	Junction temperature			-40		125	°C
T <sub>stg</sub>	Stored temperature			-40		125	°C
W <sub>t</sub>	Weight				1560		g
Outline	M14						

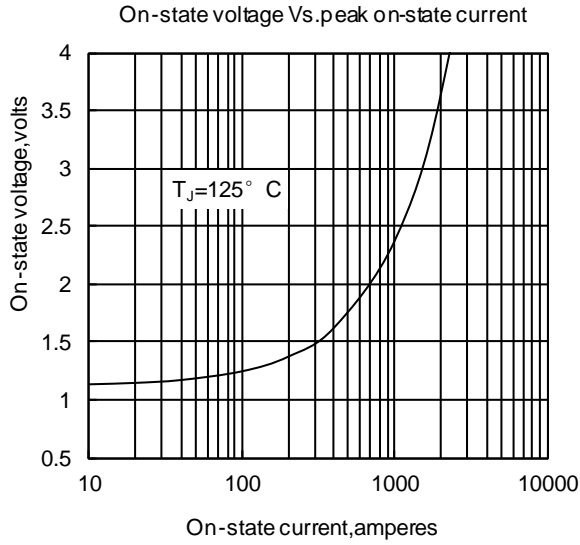

Fig1

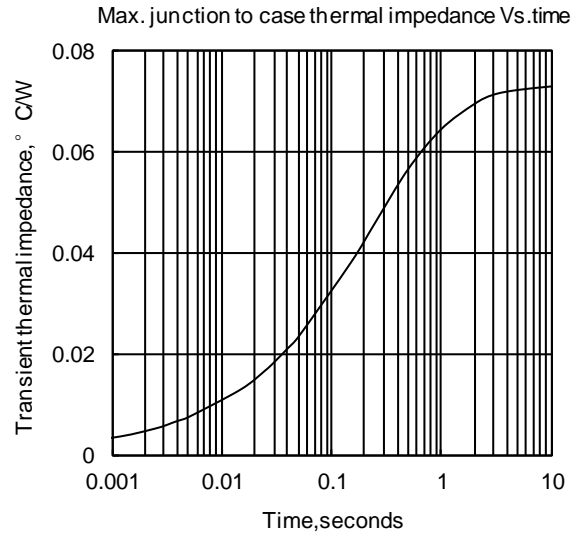

Fig2

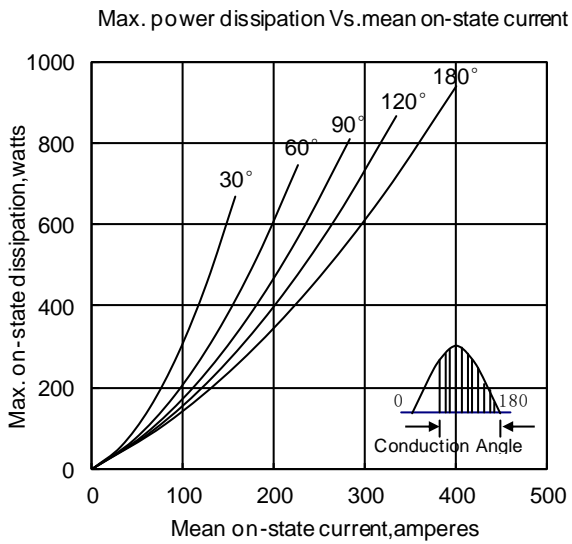

Fig3

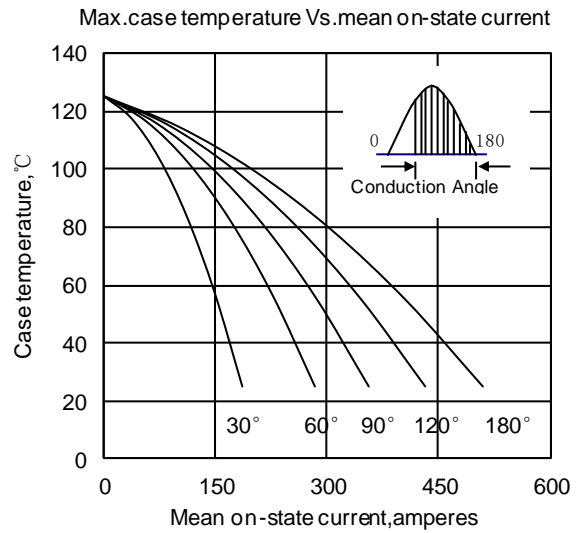

Fig4

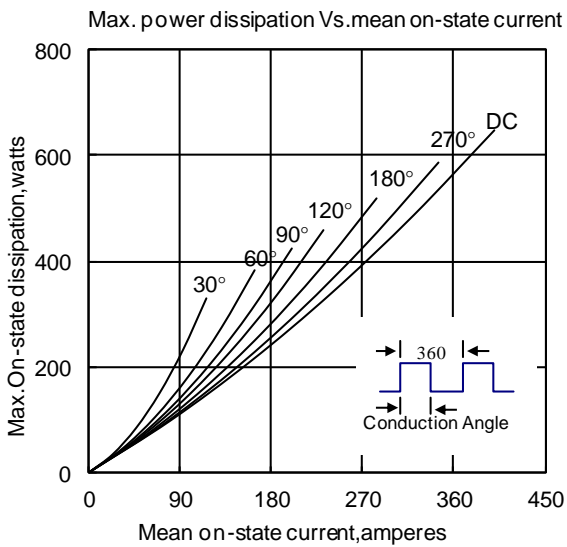

Fig5

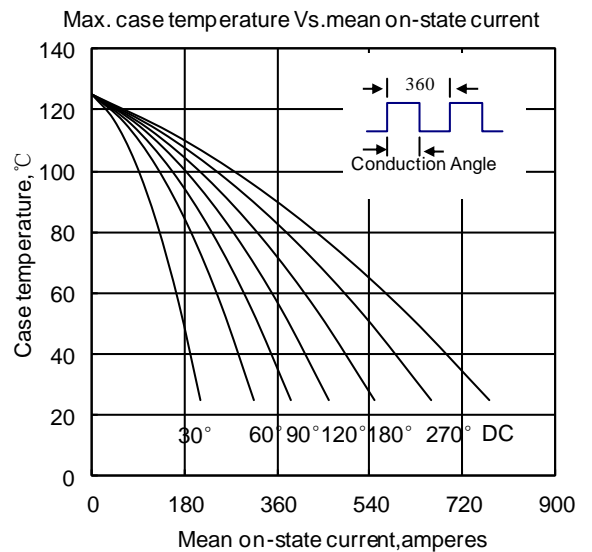

Fig6

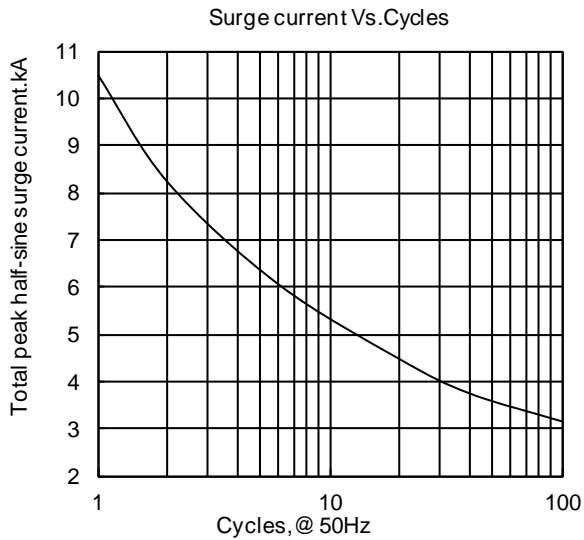

Fig7

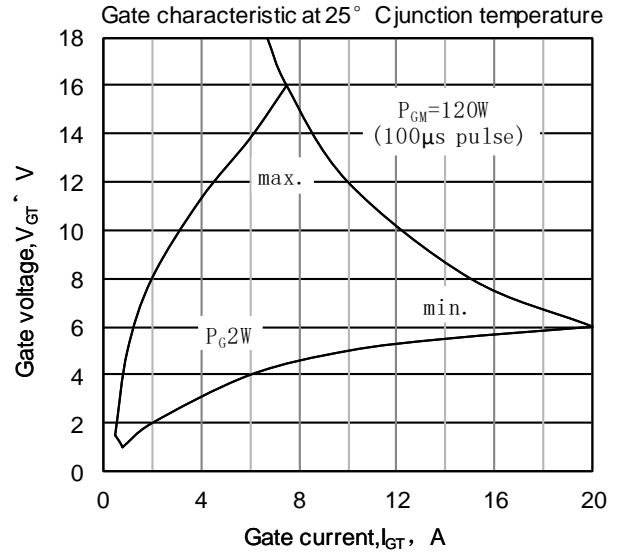

Fig8

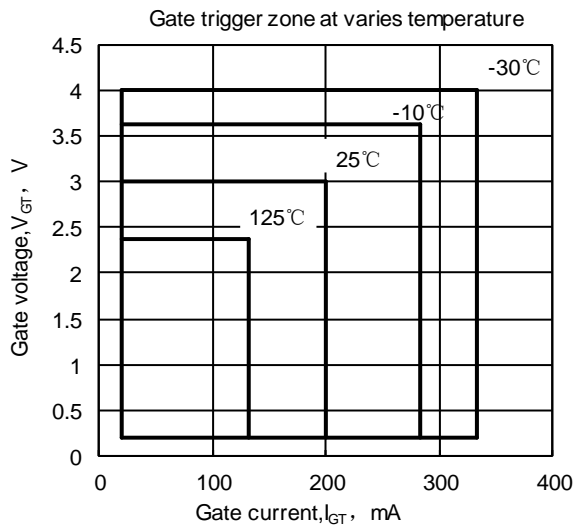
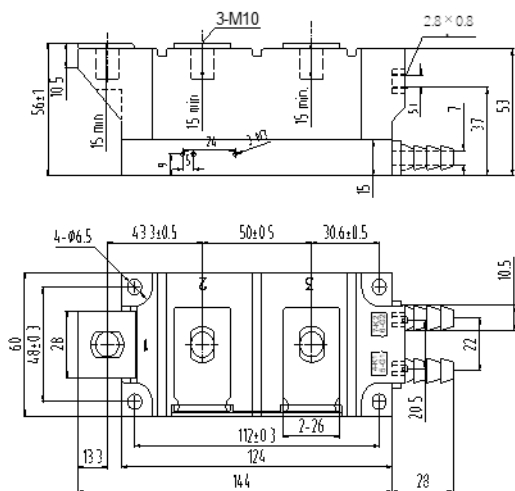

Fig9



MD400T\*\*W

MR400T\*\*W

MC400T\*\*W

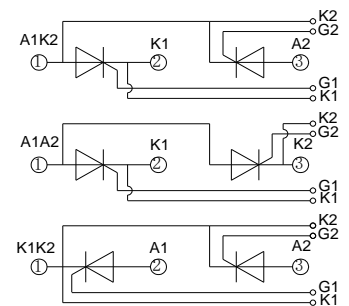

Unmarked dimensional tolerance : ±0.5mm

Nips reserves the right to change specifications without notice.