

Features

- Low forward voltage drop
- High reverse voltage
- Hermetic metal cases with ceramic insulators

Typical Applications

- All purpose high power rectifier diodes
- High power resistance welding equipment
- Non-controllable and half-controllable rectifiers
- Controlled rectifiers

$I_{F(AV)}$ 2490A
 V_{RRM} 1100~2000 V
 I_{FSM} 25.7 kA
 I^2t 3302 10^3A^2S



SYMBOL	CHARACTERISTIC	TEST CONDITIONS		$T_I(^{\circ}C)$	VALUE			UNIT
					Min	Type	Max	
$I_{F(AV)}$	Mean forward current	180° half sine wave 50Hz Double side cooled,	$T_C=85^{\circ}C$	175			2490	A
V_{RRM}	Repetitive peak reverse voltage	$t_p=10ms$		175	1100		2000	V
I_{RRM}	Repetitive peak current	at V_{RRM}		175			80	mA
I_{FSM}	Surge forward current	10ms half sine wave		175			25.7	kA
I^2t	I^2t for fusing coordination	$V_R=0.6V_{RRM}$						3302
V_{FO}	Threshold voltage			175			0.89	V
r_F	Forward slope resistance							0.15
V_{FM}	Peak forward voltage	$I_{FM}=4500A, F=24kN$		175			1.57	V
Q_{rr}	Recovery charge	$I_{FM}=2000A, t_p=2000\mu s, di/dt=-20A/\mu s, V_R=50V$		175		3500		μC
$R_{th(j-c)}$	Thermal resistance Junction to case	DC: double side cooled					0.020	$^{\circ}C / W$
$R_{th(c-h)}$	Thermal resistance case to heat sink	Clamping force 24kN					0.005	
F_m	Mounting force				19		26	kN
T_{stg}	Stored temperature				-40		175	$^{\circ}C$
W_i	Weight					440		g
Outline	P42							

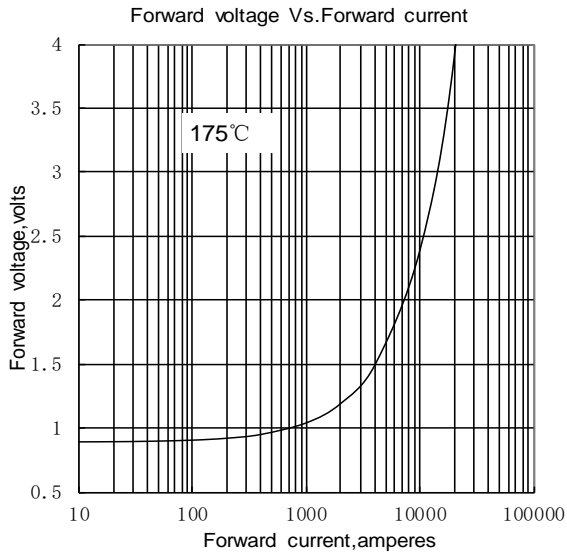

Fig.1

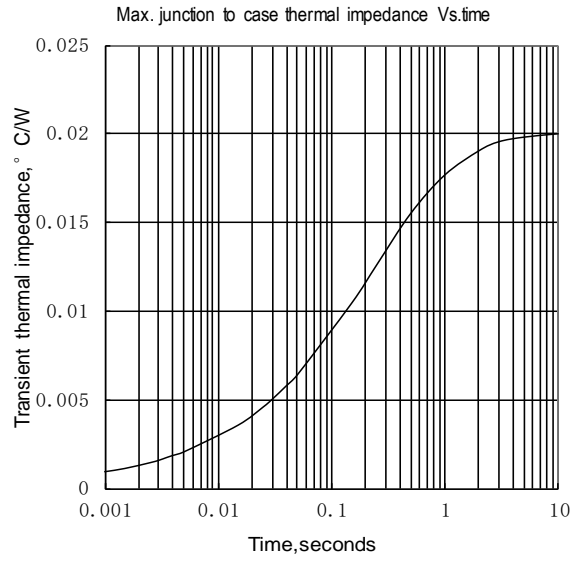

Fig.2

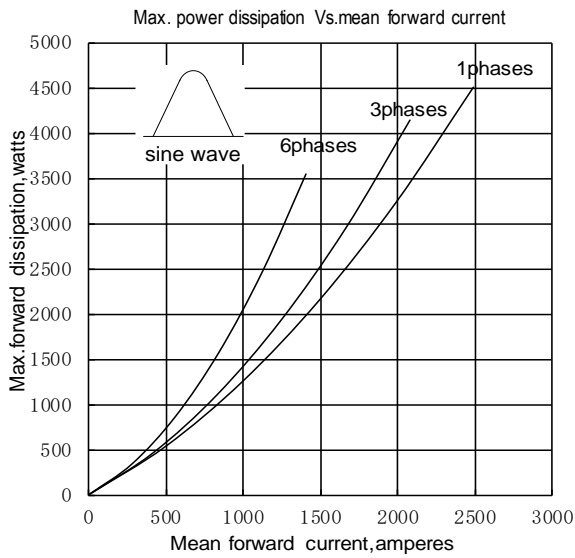

Fig.3

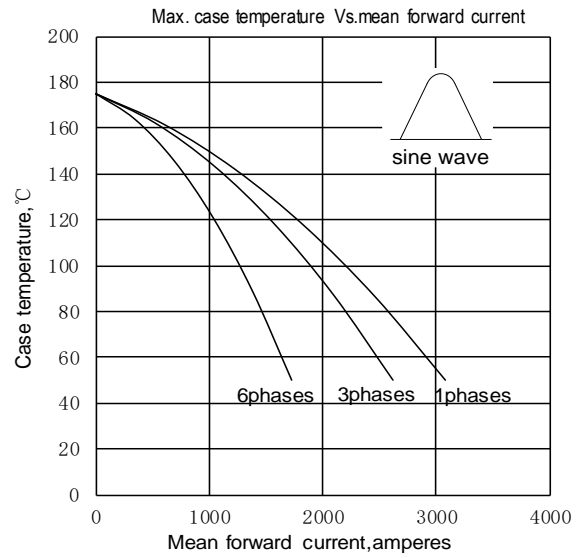

Fig.4

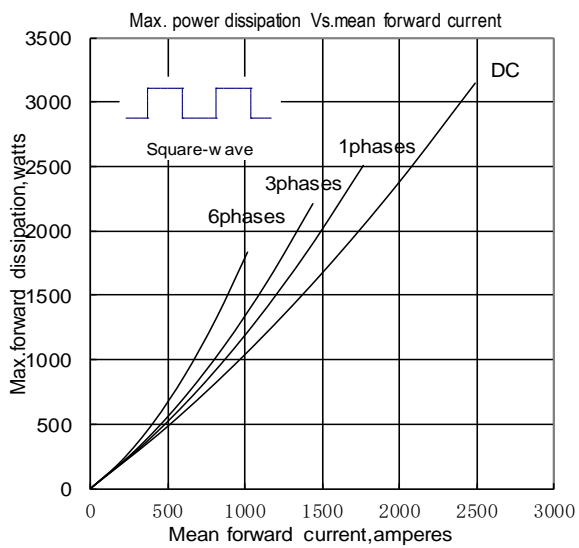

Fig.5

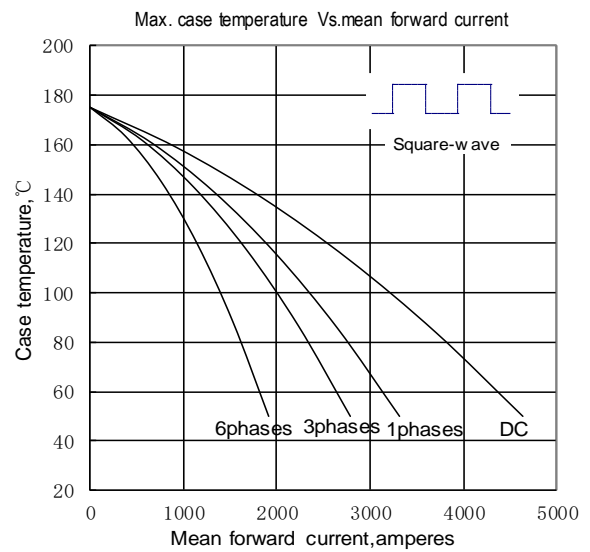

Fig.6

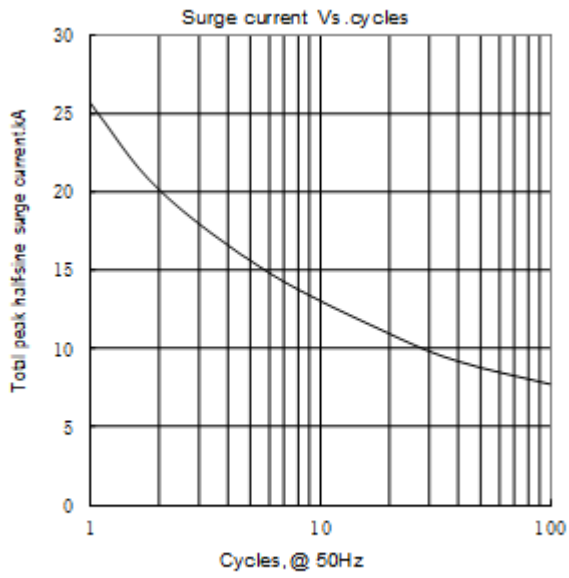
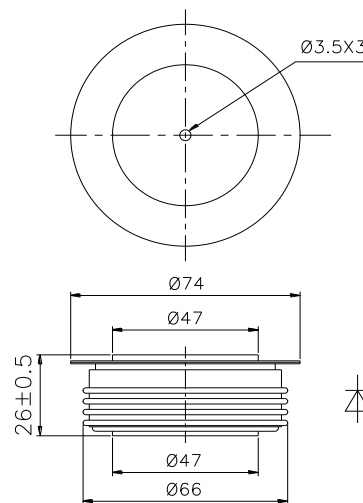

Fig.7



Nlps reserves the right to change specifications without notice.